



Sprint User Guide

A downloadable, printable guide to your device and its features.

MOBILE HOTSPOT
R850



Table of Contents

Introduction	1
Before You Begin	1
Compatible Operating Systems (OS)	1
Package Contents	2
> SSID and Security Key	2
Additional Information	2
Get Started	3
Parts and Functions	3
Home Screen	4
Home Screen Layout	4
Home Screen Icons	4
Data Transfer Volume and Transfer Speed	5
SIM Card	5
Handling a SIM Card	5
Insert or Remove a SIM Card	6
Battery Use	9
Insert the Battery	9
Charge the Battery	11
Turn Your Device On and Off	12
Connect with Wi-Fi (WLAN)	14
Wi-Fi (WLAN) Overview	14
Activate Wi-Fi (WLAN) Function	14
Connect Windows PCs with Wi-Fi	15
Connect Mac Computers with Wi-Fi	16
Connect iPhone/iPod Touch/iPad	19
Connect an iPhone or an iPod Touch	19
Connect an iPad	22
Connect an Android Device	25
Settings	29
Web UI Overview	29
Web UI Window	29
Home	29
Admin Log in	30

Connected Devices	30
Settings Tab	32
Wi-Fi Basic Settings	32
Wi-Fi Advanced Settings	36
Mobile Network Settings	37
Device Settings	41
Advanced Router Settings	45
About	50
Support Tab	51
Appendix	53
Troubleshooting	53
Specifications	54
Warranty and Service	56
Warranty	56
Services	57
Customer Service	57
Trademarks and Copyright Information	57
Safety and Notices	58
Safety Precautions	58
Important Notice	58
Safety and Hazards	58
Proper Battery Use and Disposal	59
FCC Compliance	59
RF Exposure Information and Specific Absorption Rate (SAR) Information	60
Index	61

Introduction

The following topics describe the basics of using this guide and your new mobile broadband device.

Before You Begin

Thank you for purchasing your new R850 Mobile Hotspot. The following topics explain how best to use this guide to get the most out of your mobile broadband device.

Before Using Your Device

Read [Safety and Notices](#) thoroughly for proper usage.

Accessible services may be limited by subscription contract conditions.

Guide Usage Notes

Note that most descriptions in this guide are based on your device's default settings at the time of purchase.

Screenshots and Key Labels

Screenshots and Key labels are provided for reference only. Actual windows, menus, etc. may differ in appearance.

Other Notations

In the user guide, the mobile broadband device may be referred to either as "mobile broadband device", "hotspot", "device" or "Wi-Fi router."

Compatible Operating Systems (OS)

The table below outlines the compatible operating systems (OS) for your device. Use outside these environments may affect performance. Additional factors (hardware, connected peripherals, installed applications, etc.) may also affect performance.

- For computer support, OS version upgrade information, etc., see the corresponding manufacturer's product support documentation.
- The information for operating system (compatible OS) listed below is the current information for your device sold as of Feb 2016.

Item	Description
Compatible operating systems (OS)	Windows 7, 8, 10 MacOS 10.5 or later Android 2.1 or later
Compatible browsers	Chrome 36.0 or later Internet Explorer 8.0 or later Firefox 3.1 or later Safari 5.0 or later

Package Contents

See below for details on everything you will find in the box for your R850:

- R850 Mobile Hotspot
- Battery Cover
- Rechargeable Battery
- AC Adapter
- Get Started Guide
- Important Information Booklet

SSID and Security Key

Before connecting Wi-Fi devices to your R850, you will need to confirm the WiFi Name and WiFi Password.

- Once your device display is on, short press the menu button (power button) 1 time for the WiFi Name and twice to obtain WiFi Password specific to your device (Note: when the device display is off, the first press wakes up the display.)
- ❖ You will see the WiFi Name (SprintWiFia-XXXXXX) and WiFi Password.

Additional Information

The following list describes additional information useful to know before you begin using your R850.

- Your mobile broadband device accommodates software updates. Always use the latest software.
- Note that connection speeds may drop or connections may be disabled depending on line traffic or connection environments.

Get Started

The following topics give you all the information you need to set up your device and wireless service the first time.

Parts and Functions

Learn your device's primary parts and functions.

Device Layout

The following illustration outlines your device's primary external features and buttons.

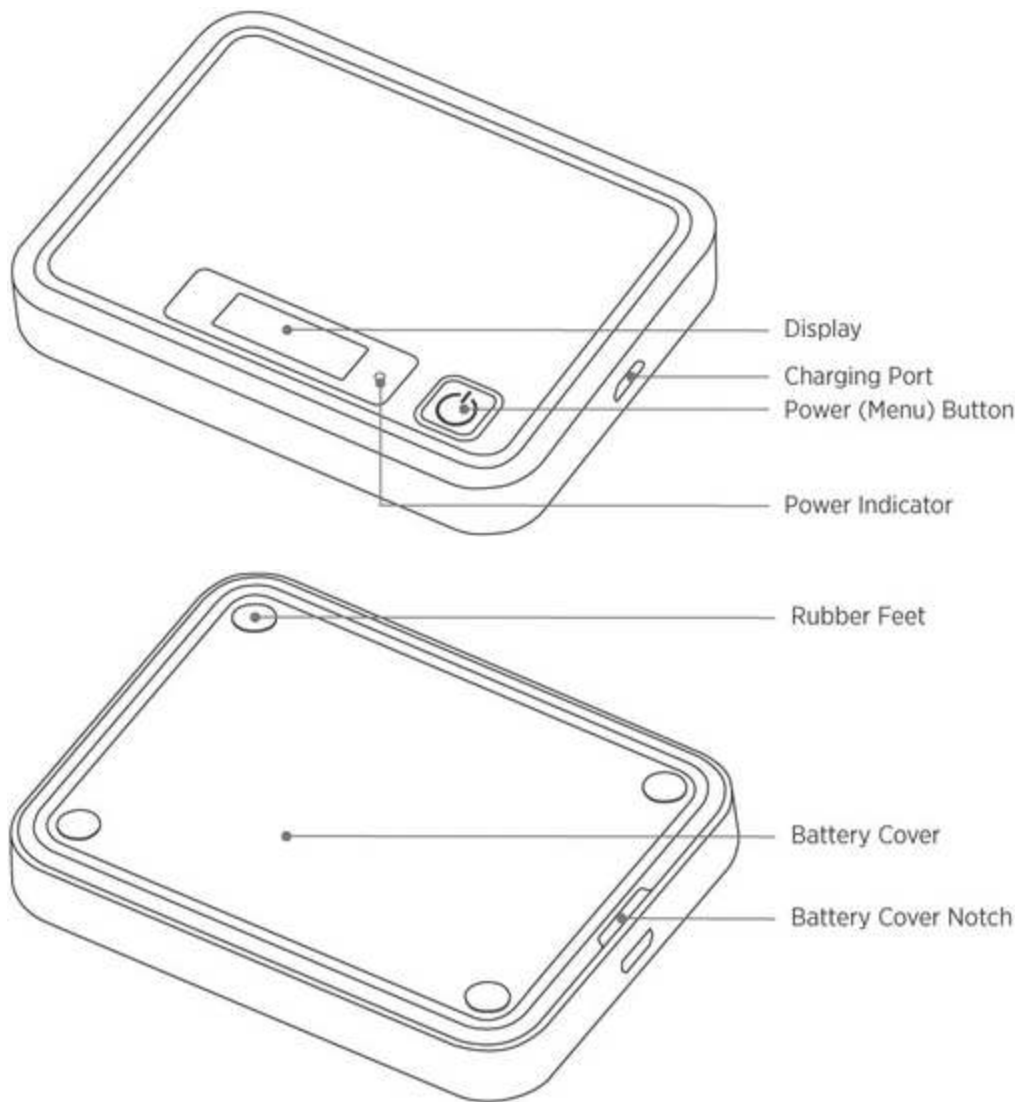

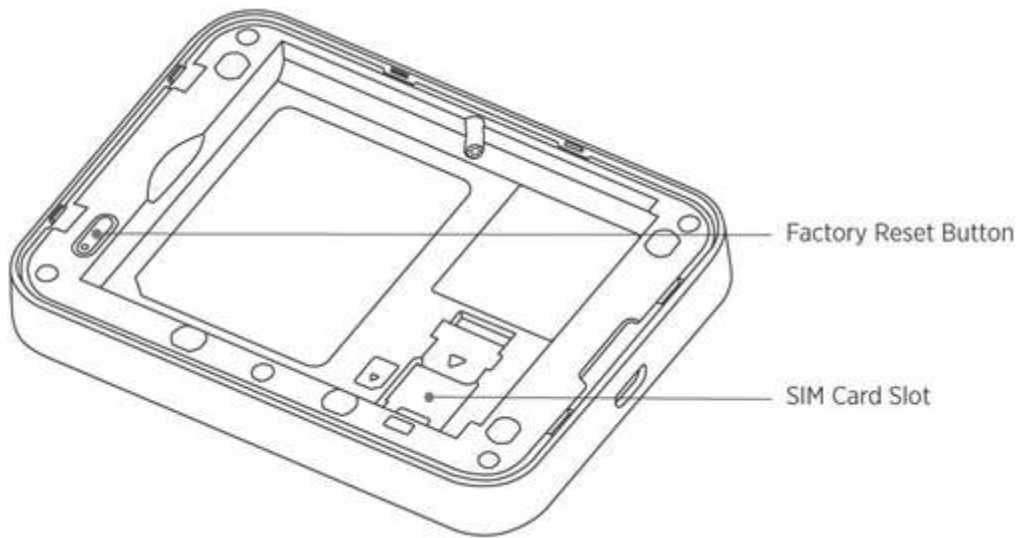

Part	Description
Display	View device status and information
SIM card slot	Install the SIM card.
Charging port	Connect the micro USB cable for charging.
Battery cover	Remove the battery cover to remove or insert the battery or SIM card.
Factory reset button	Press to reset your device to its default settings.
Power (Menu) button 	Long press to toggle power on or off. Short press to navigate device information.

Home Screen

The following topics describe the details of your device's display layout, icons, data usage and information.









Home Screen Layout

Your device's home screen displays status indicators, including the connection status, signal strength, devices connected, battery level, and more.



Home Screen Icons

The home screen features the following icons, depending on current status.

Icon	Description
	Mobile networks connected
	Service signal strength. The more bars, the better service signal received
	Out of service area
	Appears when roaming
	The number of connected WiFi devices
	Battery full
	Battery low
	No battery. Battery icon blinking (charging required)

Data Transfer Volume and Transfer Speed

The data transfer volume and transfer speed varies according to the wireless mode of your device.

Wireless Mode	Maximum Downlink Speed	Typical Downlink Speed
4G LTE	150 Mbps	50 Mbps

Note: Actual speeds depend on several factors, including network conditions.

SIM Card

The SIM card is an IC card containing your device's phone number and other customer information.

Note: Your device's SIM card is preinstalled.

Handling a SIM Card

Keep the following in mind when handling a SIM card.

- Customer is responsible for any damage caused by inserting the SIM card in another-brand IC card reader, etc. The company is not responsible in such case.
- Always keep the IC chip clean.
- Wipe clean with a dry, soft cloth.
- Avoid applying labels. May damage the SIM card.
- See instructions included with the SIM card for handling.
- The SIM card is the property of the company.
- The SIM card is replaceable (at cost) in case of loss/damage.
- Return the SIM card to the company when cancelling subscription.
- Returned SIM cards are recycled for environmental purposes.

- Note that SIM card specifications and performance may change without notice.
- It is recommended that you keep a separate copy of information that is stored on the SIM card. The company is not responsible for damages from stored information that is lost.
- Always follow emergency procedures to suspend service if your SIM card or device (SIM card inserted) is lost or stolen. For details, contact Customer Service.
- Always power off the mobile broadband device before inserting or removing the SIM card.

Insert or Remove a SIM Card

Follow these instructions to insert or remove a SIM card. Remember to power off your device before inserting or removing a SIM card.

Note: Your device's SIM card is preinstalled. These instructions are for reference only.

1. Press and hold the **Power** key  to turn off the device before inserting or removing the SIM card.

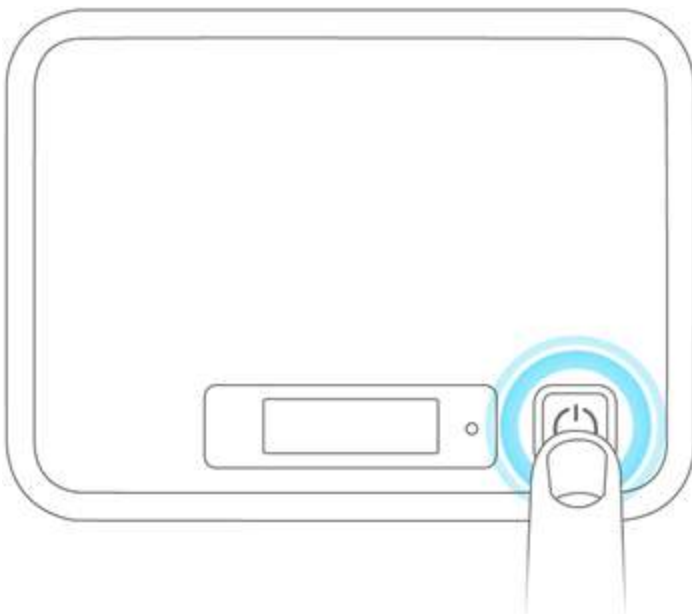

2. Remove the battery cover.

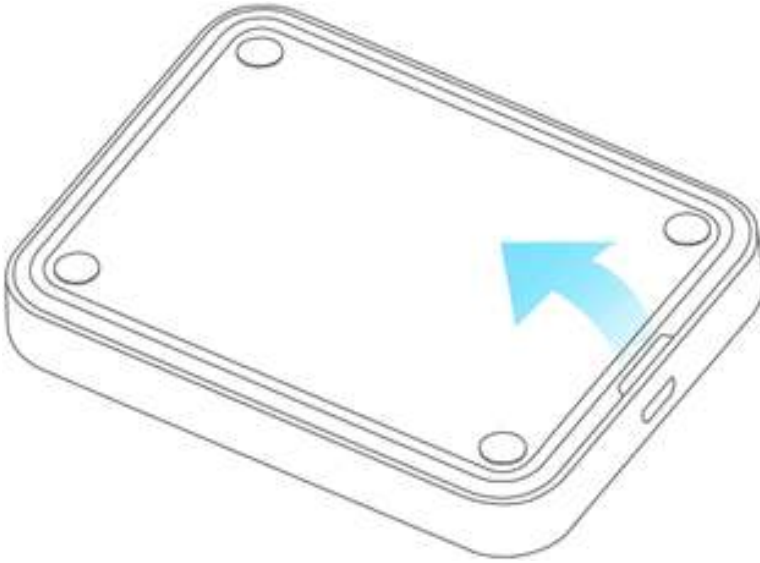

3. Remove the battery.

4. Open the SIM card cover.

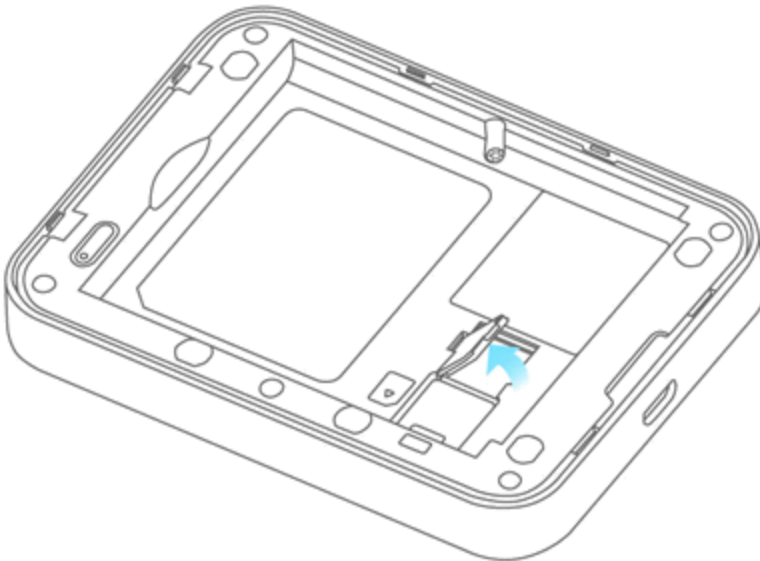

5. Insert the SIM card gently with gold IC chip facing downward.

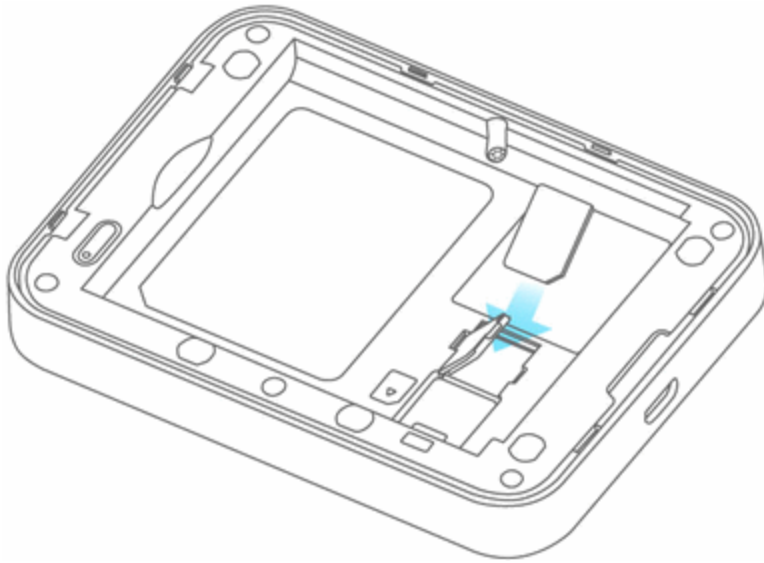

6. Remove the SIM card by gently pressing down and sliding outwards.

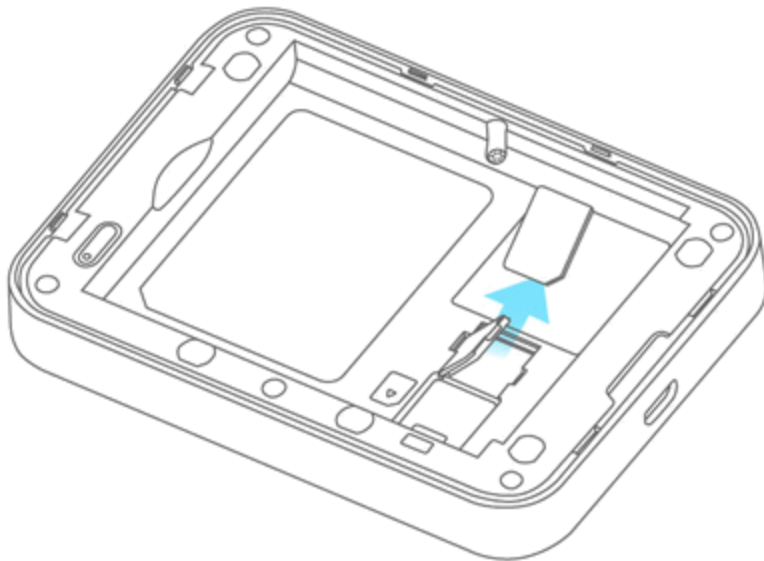

7. Close the SIM card cover.

8. Insert the battery.

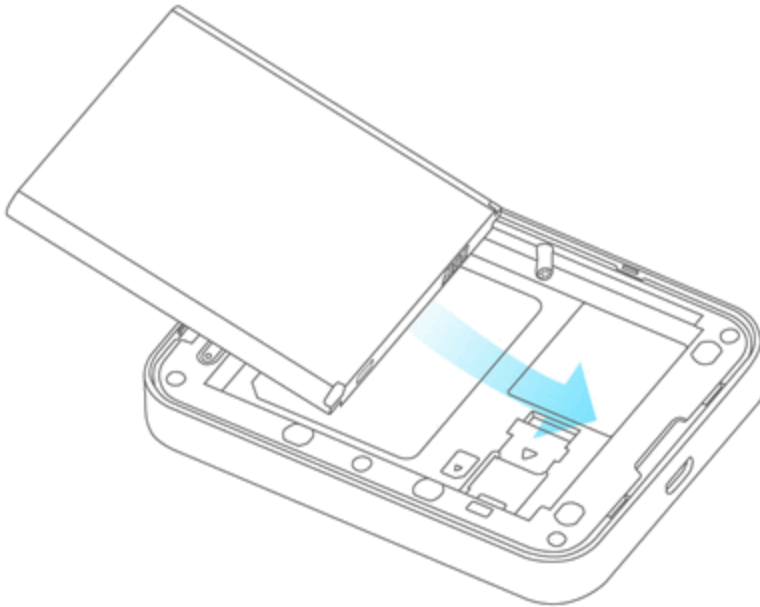

- Align the contacts of the battery with the contacts in the device.

9. Attach the battery cover.

Battery Use

The following topics explain how to insert and remove your device's battery.

Battery Cautions

Storage: Avoid storing or leaving the battery with no charge remaining. Saved information and settings may become lost or changed, or battery may become unusable. Charge once every six months before storing or leaving unused for a long period.

Bulges: Depending on use, bulges may appear near end of battery life. This does not affect safety.

Battery Replacement: The battery is a consumable item. It needs to be replaced if operating time shortens noticeably. Purchase a new battery.

Cleaning: Clean soiled terminals between battery and device with a clean, dry cotton swab. Soiled terminals can result in a poor connection and prevent charging, etc.

Insert the Battery

Follow these instructions to insert your device's battery safely and properly.

1. Press and hold the **Power** key  to turn off the device before inserting or removing the battery.

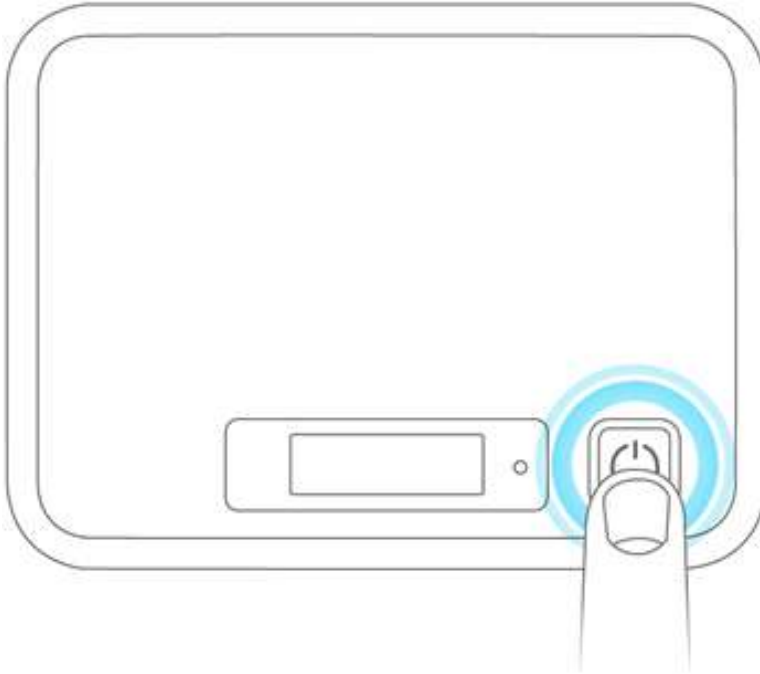

2. Remove the battery cover.

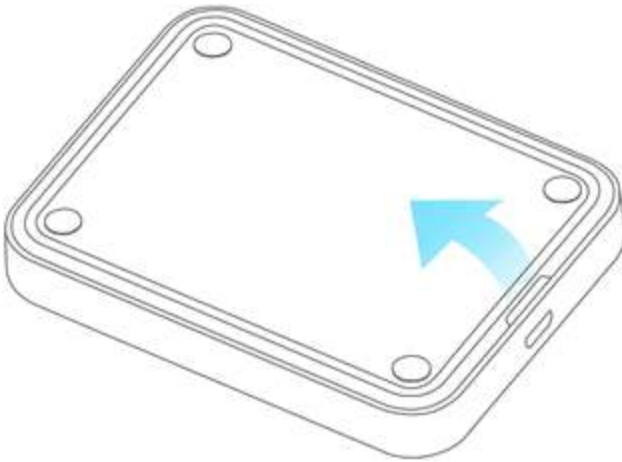

3. Insert the battery.

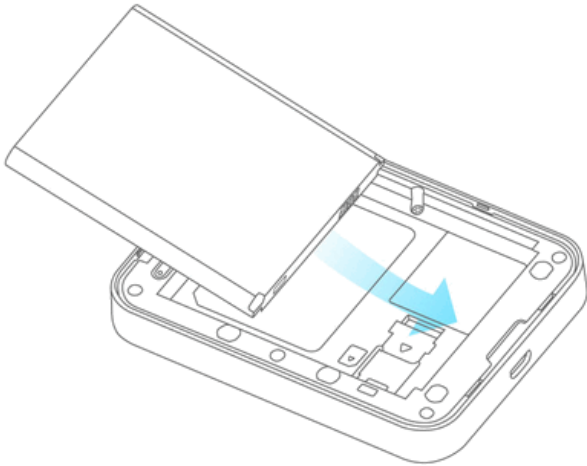

4. Replace the battery cover.

Charge the Battery

Follow these instructions to charge your device's battery using the included AC adapter.

Battery Charging Cautions

Charging Conditions: Under low temperatures charging performance decreases. Charge your device in temperatures between 5°C – 35°C. Do not charge in places where there is high humidity. USB charging may be unavailable depending on Wi-Fi router temperature.

Use Supplied Accessories: Always use the supplied AC adapter.

Precaution for Extended Use: Your device may become hot when used for a long time or while charging, especially in high temperatures. Prolonged contact with skin may cause low-temperature burn injuries.

The R850 and AC Adapter Becoming Warm or Hot: Your device and the AC adapter may become warm while charging. This is not a malfunction. However, stop using them immediately if they become extremely hot; this could indicate a malfunction.

Charge Using the AC Adapter

Use the supplied AC adapter.

1. Plug the AC adapter into an electrical outlet.
 - ❖ The indicator light on the power button illuminates red when charging starts. The light turns green when the battery is fully charged. Fully charging a battery may take up to three hours.
2. After charging, disconnect the device from the charger.

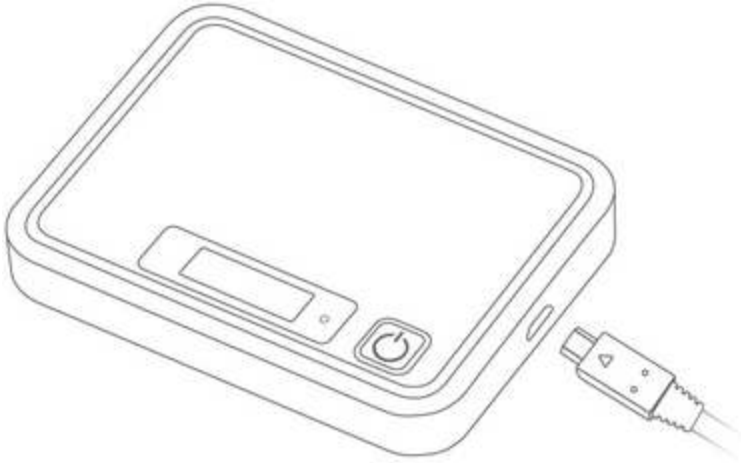

- Unplug the AC adapter from the outlet, and remove the micro USB connector from the device.

Turn Your Device On and Off

The instructions below explain how to turn your device on and off, and how to restart your device if it cannot be powered on and off using the **Power** button .

Turn Your Device On

- Press and hold the **Power** button  until the device displays "Welcome."

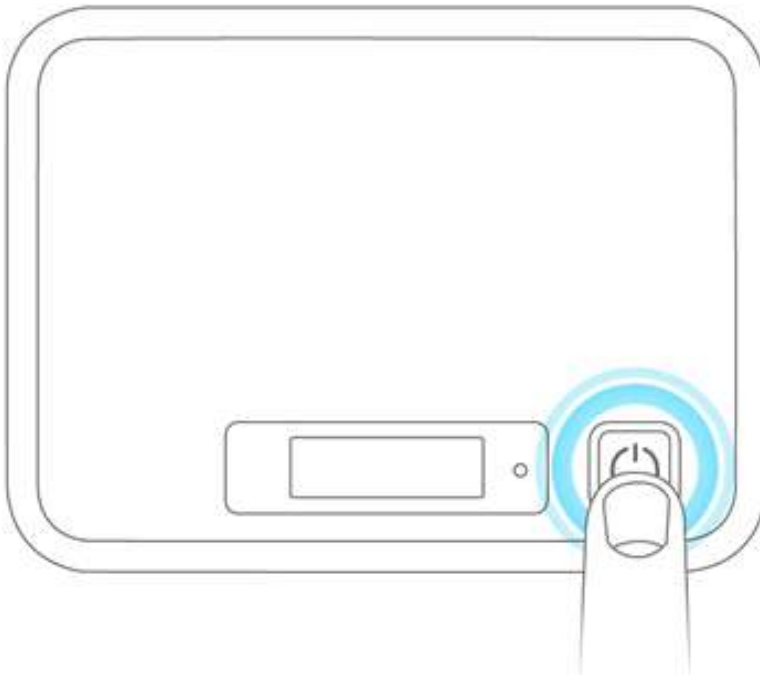

Turn Your Device Off

- Press and hold the **Power** button  until the device displays "Goodbye."
- Your device will power off.

Restart Your Device

If your device will not turn on or off using the Power button, remove and re-insert the battery (see the section [Insert the Battery](#)), then press and hold the power button again.

Note: Restarting your device does not reset the device settings.

Connect with Wi-Fi (WLAN)

The following topics outline basic features and operations of your device's Wi-Fi (WLAN) connections, including connecting with various OS and device types.

Wi-Fi (WLAN) Overview

Below are some basics of your device's Wi-Fi (WLAN) function.

Wi-Fi (WLAN) Information

- **Advanced Settings:** Change your device's Wi-Fi (WLAN) settings as required. See [Wi-Fi Advanced Settings](#)
- **Simultaneous Connection:** Use your device to connect up to 10 Wi-Fi devices simultaneously.
- **Automatic Updates for Optimizing Wi-Fi Connection:** When connected by Wi-Fi, connection optimizing settings may be automatically received and updated.

! Wi-Fi (WLAN) Usage Cautions

For added security, it is recommended that you change the default Wi-Fi network name (SSID) and Wi-Fi password after setting up your device.

Wi-Fi (WLAN) Overview

- Your device supports IEEE 802.11 b/g/n standards. Connect Wi-Fi devices (PC, game console, etc.) via Wi-Fi for wireless data transfers.

Activate Wi-Fi (WLAN) Function

Follow the instructions below to activate your device's Wi-Fi function and connect to the Internet via an available 4G LTE connection. Use the Web UI to select a network.

- Press and hold the **Power** button  until the device displays “Welcome”.

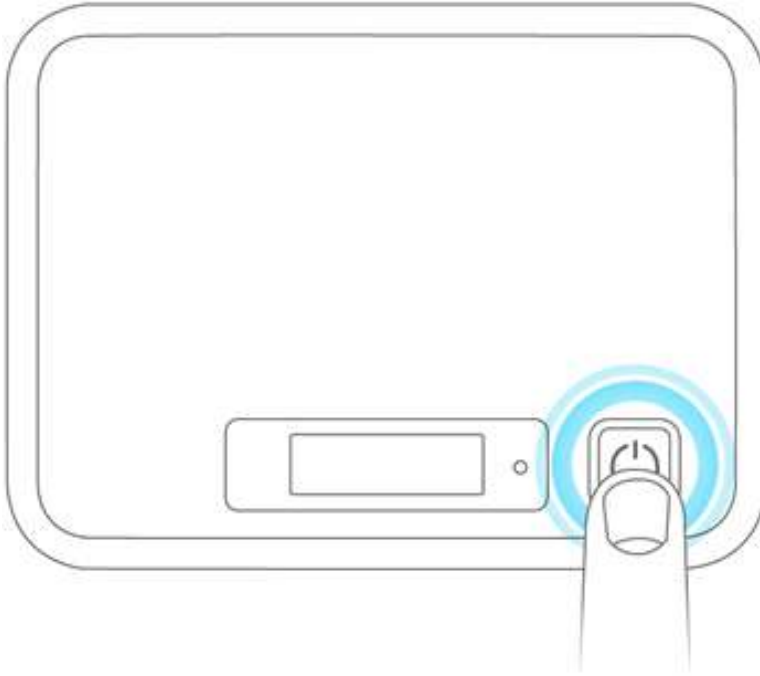



- Your device's Wi-Fi function automatically turns on once the device is powered up completely.

Connect Windows PCs with Wi-Fi

The following topics describe how to connect your device with various versions of Windows via Wi-Fi.

Connect Windows PCs to your device with Wi-Fi.

1. Press and hold the **Power** button  to power on your R850.
 - ❖ Your device's Wi-Fi function activates and automatically connects to the Internet.
2. Activate your PC's Wi-Fi function.
 - The operations depicted are based on Window 10.
 - For other Window versions, consult your PC's operation manual for details on activating Wi-Fi.
3. On your PC, move the cursor to the upper-right or lower-right corner and select WLAN icon .



4. Select your device's Wi-Fi Name (SSID) from the list, and click **Connect**.
5. Enter the Wi-Fi password and then click **Next**.



❖ The PC connects to your device. The connected status icon on your device will show an additional device has been connected.

Connect Mac Computers with Wi-Fi

Follow the instructions below to connect a Mac computer to your device via Wi-Fi.

Note: The operations depicted are based on Mac OS X 10.10.5.

1. Press and hold the **Power** button  to power on your R850.
 - ❖ Your device's Wi-Fi function activates automatically.

2. On your Mac, in the Apple menu, click **System Preferences...** > **Network**.



3. Click **Wi-Fi** > **Turn Wi-Fi On**.

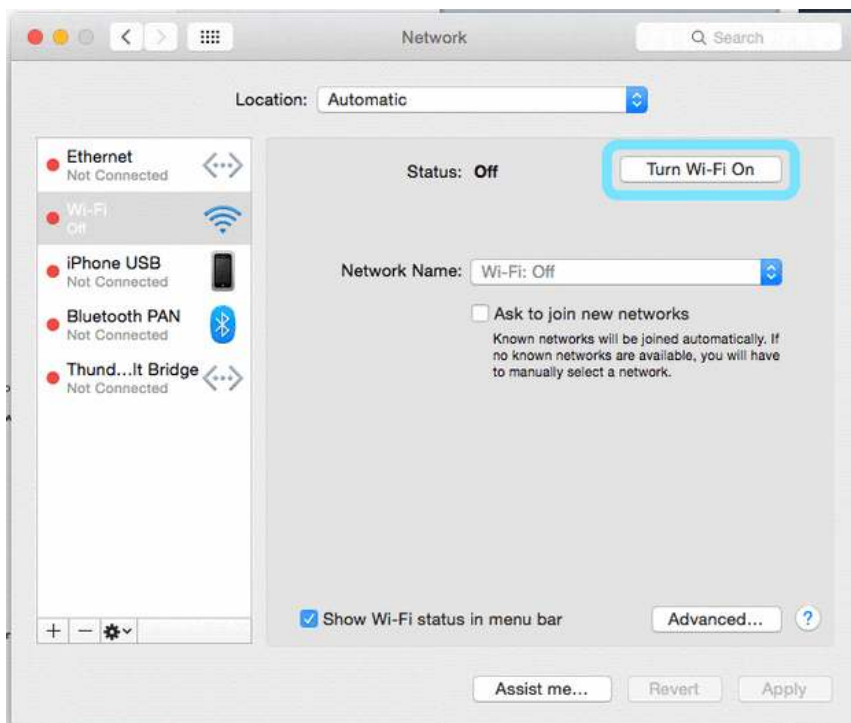

❖ Your computer's Wi-Fi function activates.

4. Select your R850's Wi-Fi Name (SSID) from the Network Name pull down list.

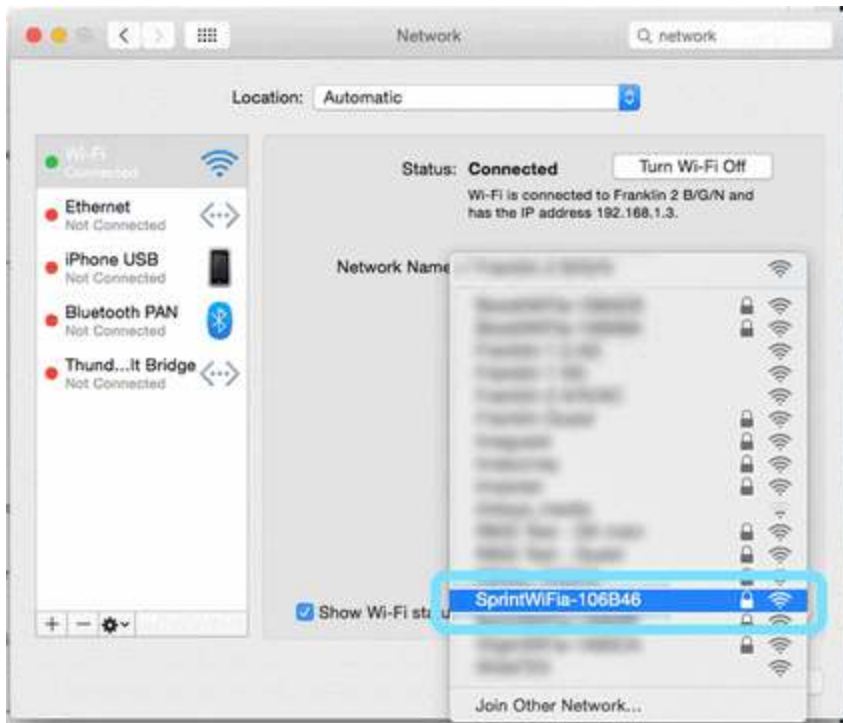

5. Enter the Wi-Fi password in the Password field; check **Remember this network**, and then click **Join**.

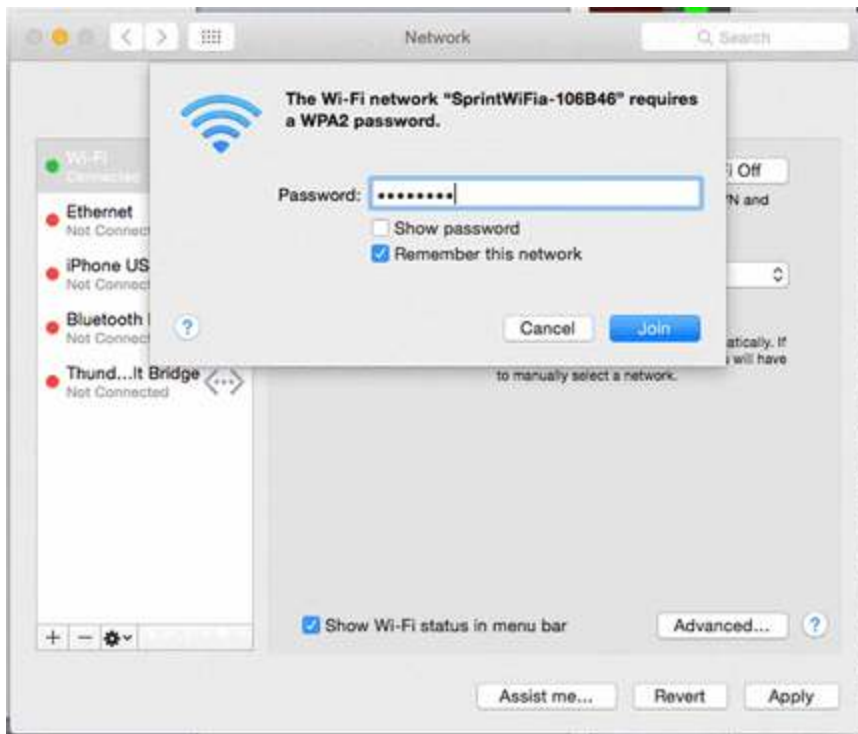

- ❖ The computer connects to your device. The connected status icon on your device will show an additional device has been connected.

Connect iPhone/iPod Touch/iPad

The following topics outline how to connect your iPhone, iPod Touch, or iPad to your device via Wi-Fi.

Connect an iPhone or an iPod Touch

Follow the instructions to connect your iPhone or iPod Touch to your device using Wi-Fi.

Note: The operations below are based on your iPhone or iPod Touch Wi-Fi security set to iOS 9.

1. Press and hold the **Power** button  to power on your R850.
 - ❖ Your device's Wi-Fi function activates and automatically connects to the Internet.
2. Select **Settings > Wi-Fi**.

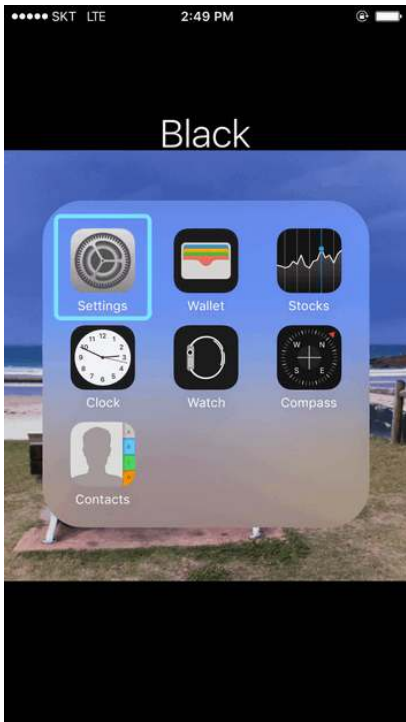

3. Select **Turn on Wi-Fi**.

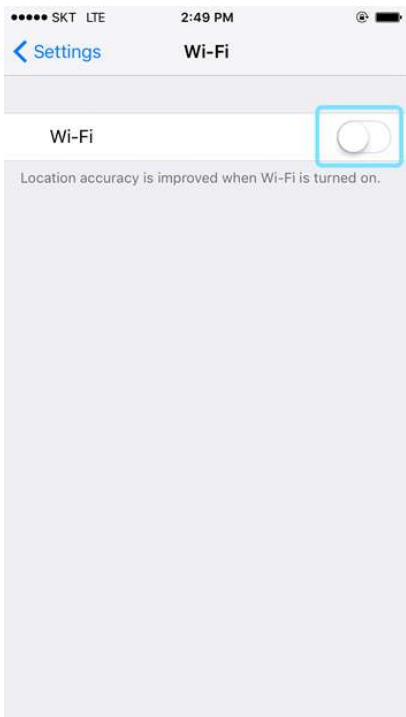

❖ The iPhone or iPod Touch's Wi-Fi function activates.

4. In the Choose a Network list, tap your R850's Wi-Fi Name (SSID).



5. Enter the Wi-Fi password and then tap **Join**.



- ❖ The iPhone or iPod Touch connects to your device. The connected status icon on your device will show an additional device has been connected.

Connect an iPad

Follow the instruction to connect your iPad to your device using Wi-Fi.

Note: The operations below are based on your iPad Wi-Fi security set to WPA/WPA2.

1. Press and hold the **Power** key .

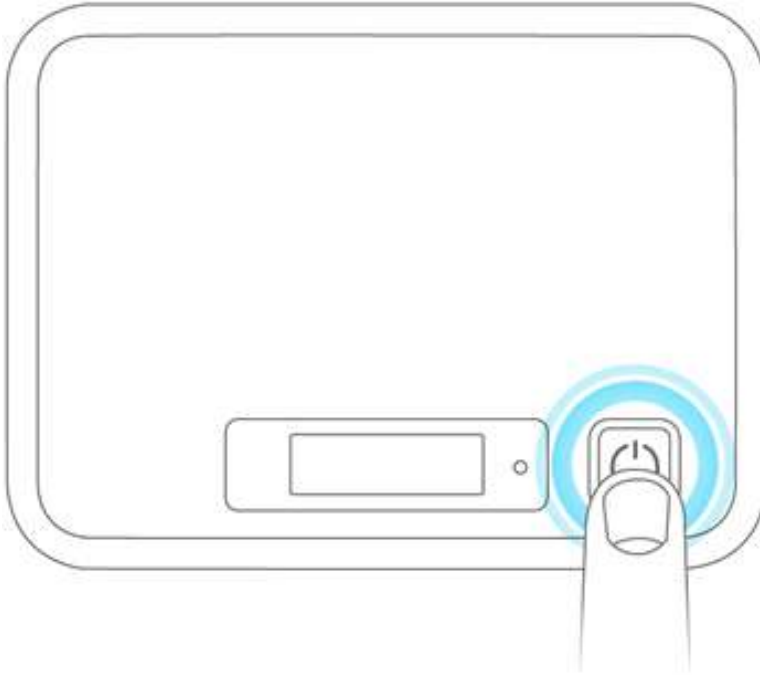

❖ Your device's Wi-Fi function activates and automatically connects to the Internet.

2. Select **Settings > Wi-Fi**.

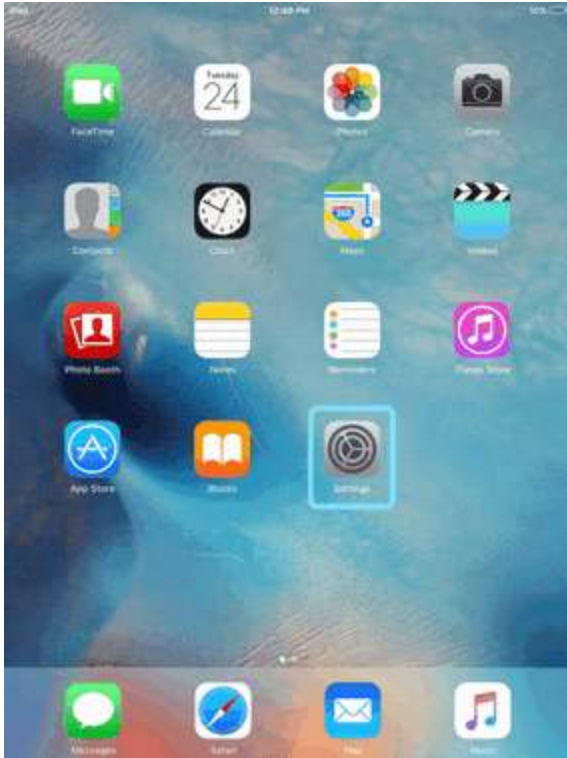

3. Select **Turn on Wi-Fi**.

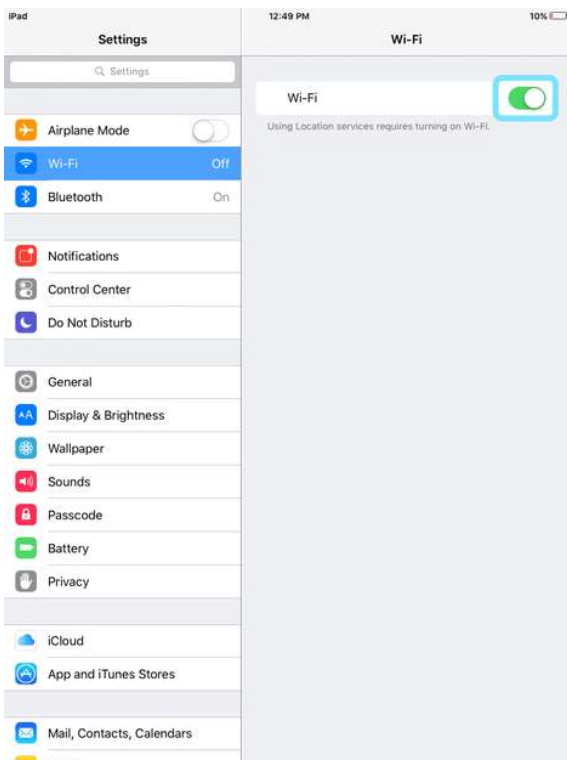

❖ The iPhone or iPod Touch's Wi-Fi function activates.

4. In the Choose a Network list, tap the device's SSID.

Connect with Wi-Fi (WLAN)

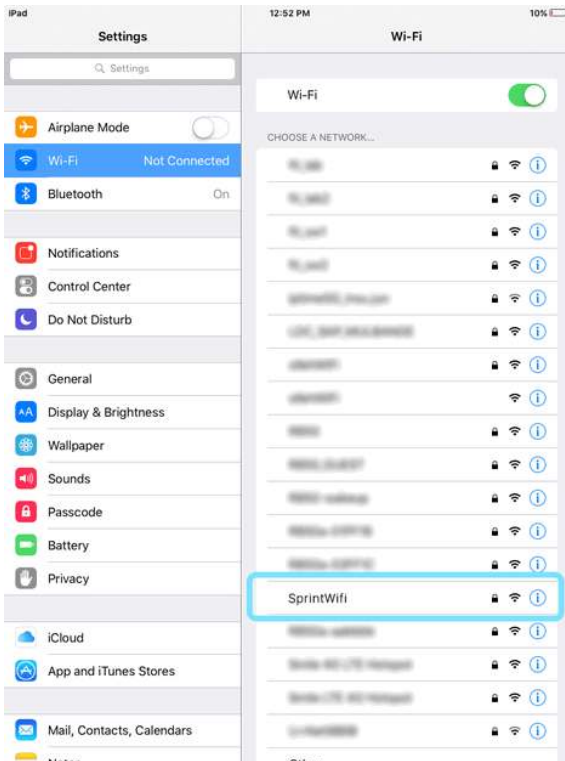

5. Enter the security key (WPA) and then tap **Join**.

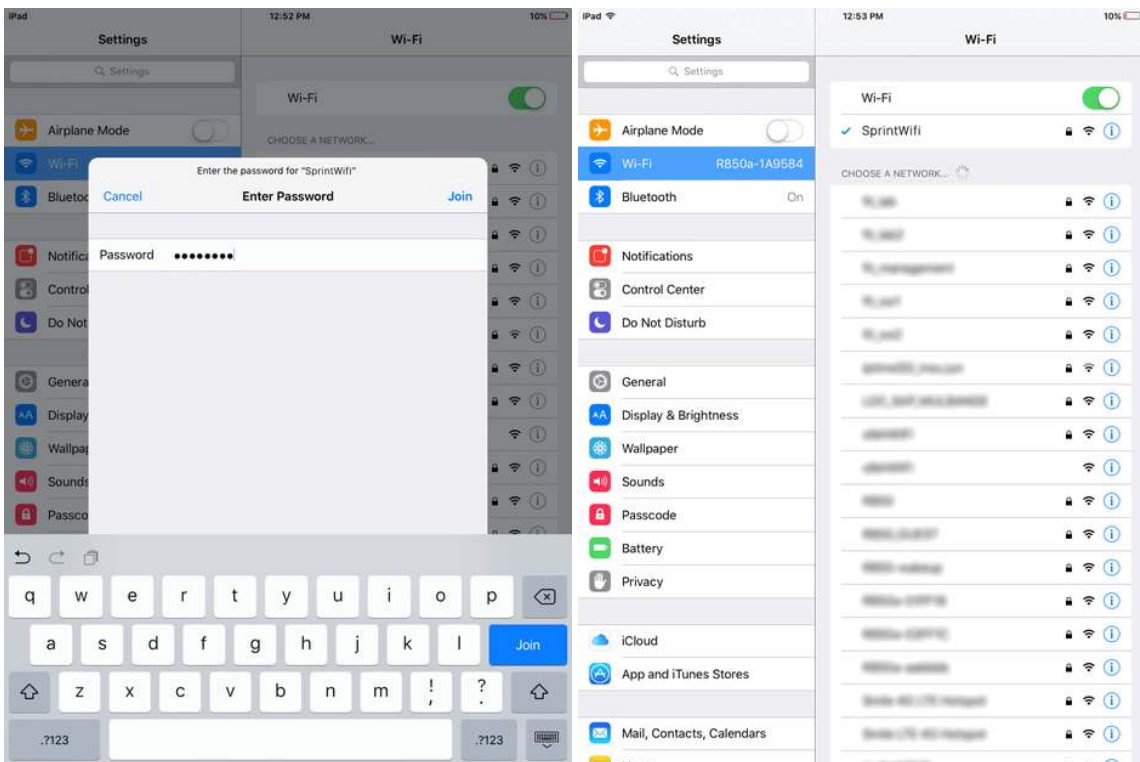

- ❖ The iPad connects to your device. The connected status icon on your device will show an additional device has been connected.

Connect an Android Device

You can share your device's connection with compatible Android devices, such as wireless phones, tablets and Chromebook computers.

Note: The operations depicted are based on Android 5.0 Lollipop. Operation may vary depending on Android device type. See your Android device user guide for details.

1. Press and hold the **Power** button  to power on your R850.
 - ❖ Your device's Wi-Fi function activates and automatically connects to the Internet.
2. On your Android device, from home, select **Menu > Settings**.

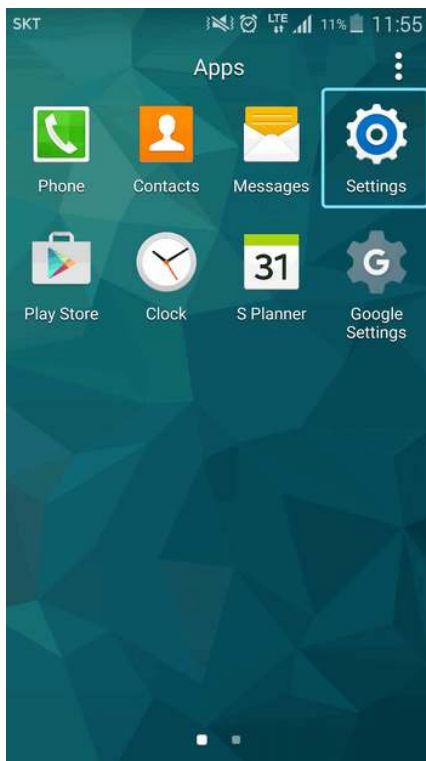

3. Tap **Wi-Fi**.

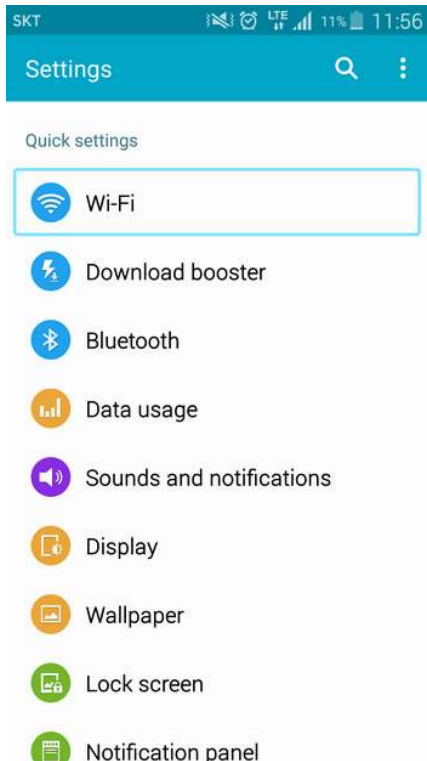

❖ The Wi-Fi settings menu appears.

4. Select the Wi-Fi slider to turn Wi-Fi on.

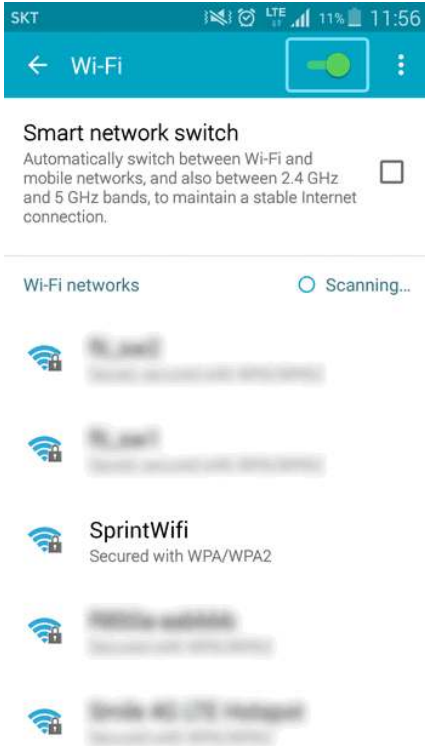

❖ Wi-Fi is enabled on the Android device.

5. Select your R850's Wi-Fi Name (SSID) from the list, and tap **Connect**.

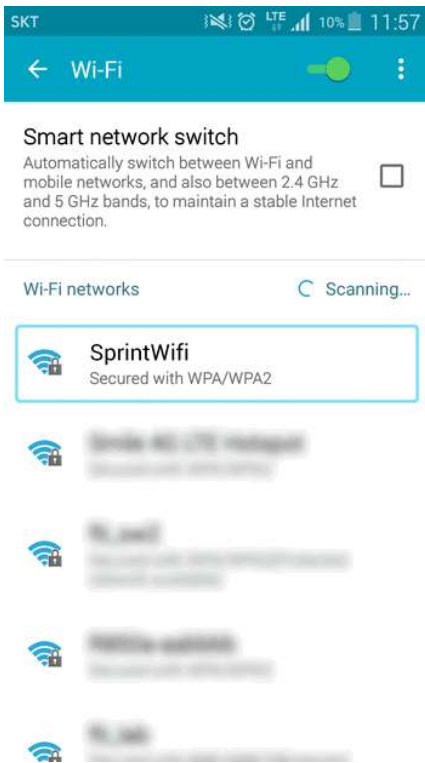

6. Enter the Wi-Fi password and then tap **Connect**.

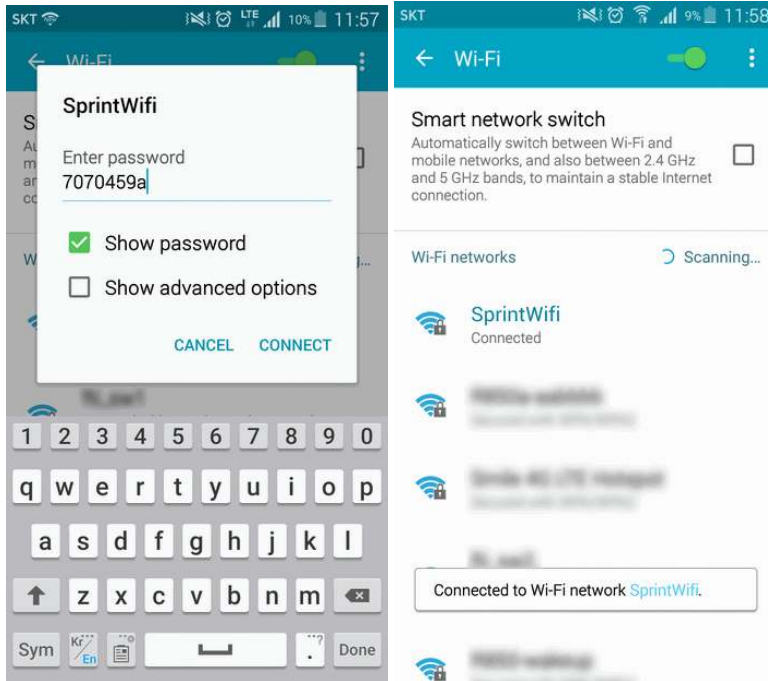

- ❖ The Android device connects to your mobile broadband device. The connected status icon on your device will show an additional device has been connected.

Settings

The following topics provide an overview of items you can change using the device **setting** menu accessed through the Web UI.

Web UI Overview

Use the device Web UI in a browser to check or change your R850 settings from a device connected via Wi-Fi.

Web UI Window

Explore the options available through the device's Web UI window.

1. Connect your R850 to an external device via a Wi-Fi connection.
2. Launch a browser and access the Web UI via <http://myhotspot> or <http://192.168.128.1>.
 - ❖ The Web UI launches and displays the main window.

Home

Check current status of network connection and data usage on the Home page.

- From the Web UI, click the **Home** tab. (For connection information, see [Web UI Overview](#).)

The screenshot displays the Sprint R850 Web UI Home page. At the top left is the Sprint logo and the text "Welcome to your R850". On the top right, there are status icons for LTE, signal strength, and a "Log in" link. Below the header is a navigation bar with five tabs: Home (selected), Connected Devices, Settings, About, and Support. The main content area is divided into two columns. The left column, titled "Connection", shows "Network Status: Connected", "Network: LTE", "Time Connected: 1:36:50", and "Data Used: 16.01 MB", with a "Disconnect" button below. The right column, titled "Data Usage", shows "Billing Cycle" with a green progress bar, "12.03 GB of Unlimited Used", "100% Remaining", and "6 Days (Next plan begins at 12/10/2015)". At the bottom of the right column, a note states: "Actual billed usage can be higher than estimated data usage displayed. For detailed data usage, go to <http://myhotspot/>". The footer of the page reads "©2015 Sprint - All Rights Reserved".

Admin Log in

Accessing other menus from the home screen requires admin log in.

1. Click "Log in" on the upper right corner of the main screen to log in. (Clicking other menus on the main screen will prompt the log in page as well.)

Enter Your Password

Password

Login Cancel

If too many incorrect passwords are tried, access will be suspended.

2. Enter the password and click "Login."

Note: The default password is "password." It's recommended to change the password for your security.

Connected Devices

The Connected Devices tab lets you confirm the names and MAC addresses of devices currently connected to your device and set access permissions.

Check the Connected Devices

- From the Web UI, click **Connected Devices** > **Connected** to display the list of connected devices.



Set Access Permissions

Control user's ability to access main or guest Wi-Fi. Changing this status will immediately update the status of devices listed ability to access Wi-Fi from this device, even if they have the password.

1. From the Web UI, click **Connected Devices > Access Permissions**.

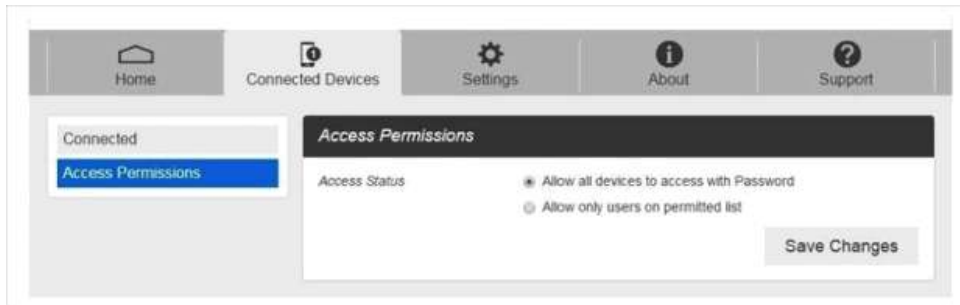

2. Select an access status and then click **Save Changes**.

Add Permitted Devices

The Access Permissions menu allows you to restrict access only to specific users, instead of anyone who enters the password. To restrict access in this manner, you need to add permitted users from the menu.

1. From the Access Permissions menu, select **Allow only users on Permitted list**.

❖ The Add Devices option will appear onscreen.

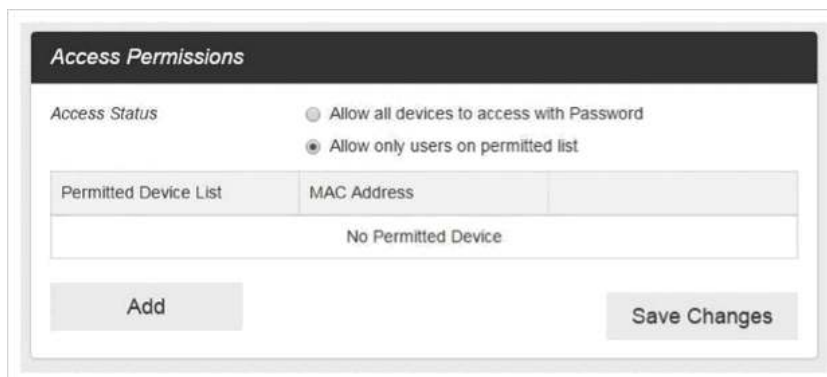

2. Click **Add** to open the Add Devices menu.
3. Enter a Friendly Name (optional) and the MAC address of the permitted device.
 - A sample MAC address might be 00:1D:0F:10:2D:D9.

Access Permissions

Access Status

Allow all devices to access with Password

Allow only users on permitted list

Permitted Device List	MAC Address
test sample	00:1D:0F:10:2D:D9

OK Cancel

Add Save Changes

4. Click **OK** to MAC address of the permitted device to the list.
 5. Click **Add** if you wish to add more permitted devices.
 6. When you are finished adding permitted devices, click **Save Changes**.
- ❖ Access to your device will be restricted to the devices in your list.

Settings Tab

Set your device options, including Wi-Fi, Mobile Network, Device and Advanced Router Settings.

Wi-Fi Basic Settings

Set the basic Wi-Fi settings for your device.

- From the Web UI, click **Settings > Wi-Fi > Basic** to display the basic wireless network parameters.

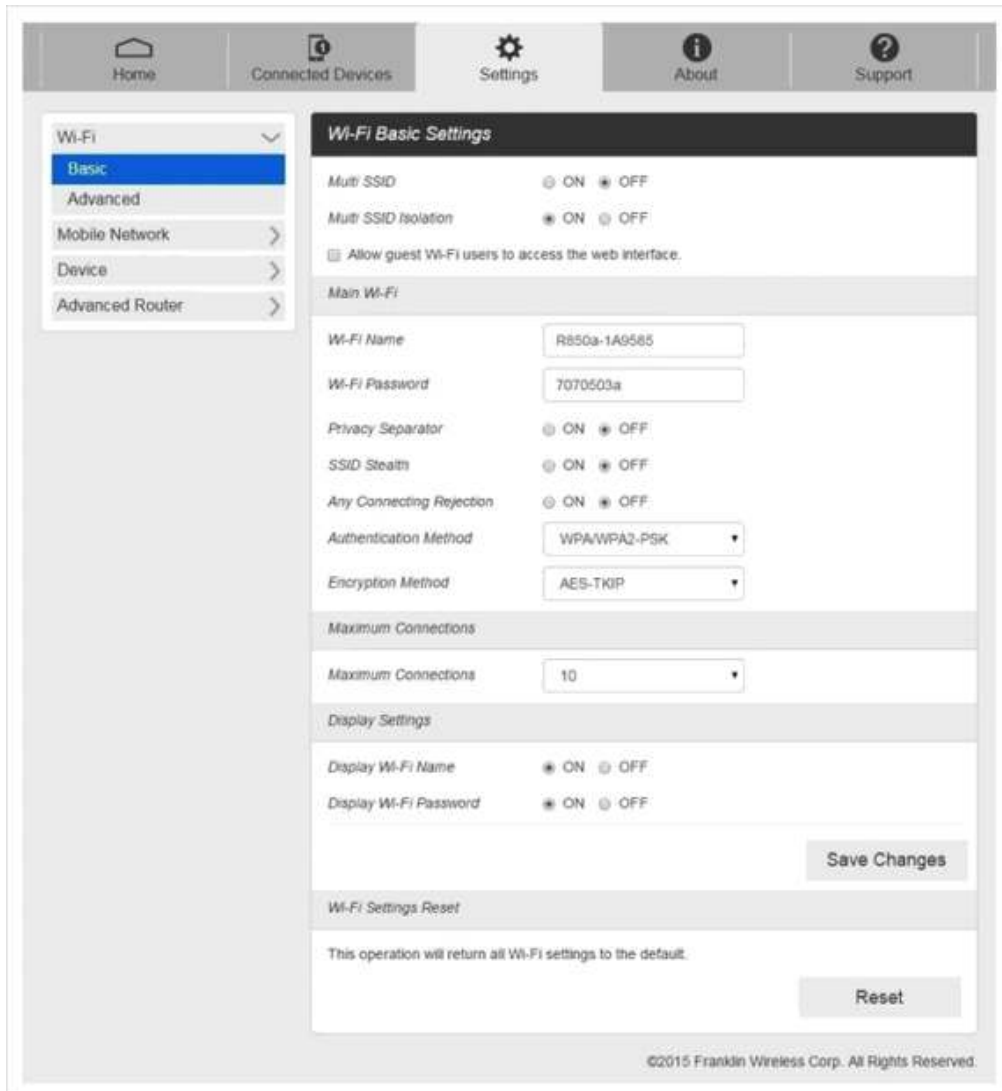

- **Multi SSID:** Select ON if you like to set up a separate guest Wi-Fi network. Your R850 will broadcast two Wi-Fi Names.
- **Guest Wi-Fi:** If ON is selected for Multi SSID, Guest Wi-Fi menu will appear. You can change Guest Wi-Fi settings.

Guest Wi-Fi

Wi-Fi Name: R850b-1A97A3

Wi-Fi Password: 7070503b

Privacy Separator: ON OFF

SSID Stealth: ON OFF

Any Connecting Rejection: ON OFF

Authentication Method: WPAWPA2-PSK

Encryption Method: AES-TKIP

Maximum Connections

Maximum Connections: 10

Main Wi-Fi: 5 +

Guest Wi-Fi: 5 +

- **Multi SSID Isolation:** If On is selected, it prevents your devices from communicating across the Main and Guest Wi-Fi access points.
- **Allow Guest Wi-Fi users to access the Web interface:** If the box is checked, users on the Guest Wi-Fi also can access the Web User Interface.
- **Wi-Fi Name:** Service Set Identifier (SSID). To change it, enter a string less than 32 characters as the name for your wireless local area network (WLAN).
- **Wi-Fi Password:** To change, enter the new Wi-Fi password. The password needs to be at least 8 characters long.
- **Privacy Separator:** If ON is selected, your devices on the same Wi-Fi Name can't make Local Area Network communication.

Note: if you connect WLAN printer to your R850, Privacy Separator should be OFF to send file from your PC to the printer.

- **SSID Stealth:** If OFF is selected, the Wi-Fi name won't be found by other devices around it. You need to manually enter the Wi-Fi name and connect.

- **Authentication Method:** The authentication methods are described below.

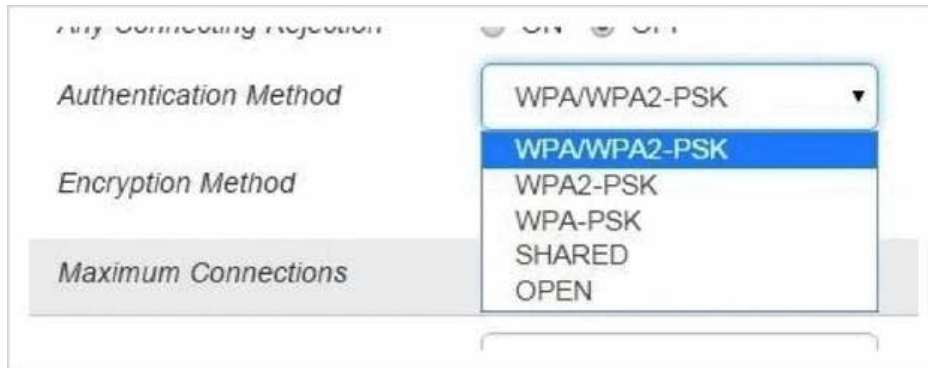

Mode	Description
OPEN	Authentication and encryption won't be performed. There are risks that private info will be intercepted or network will be used by unauthorized individuals.
SHARED	Authentication via Shared Key protocol.
WPA2-PSK	WPA-PSK is the securer version of WPA with implementation of the 802.11i standard.
WPA-PSK/WPA2-PSK	Apply both the WPA-PSK and WPA2-PSK scheme.

- **Encryption Method:** Select an encryption method from the drop-down list.



- **Maximum Connections:** Choose the maximum number of the devices which connect to your device simultaneously. You can also click the right or left arrow to distribute the maximum number of the connected devices between the Main Wi-Fi and the Guest Wi-Fi.

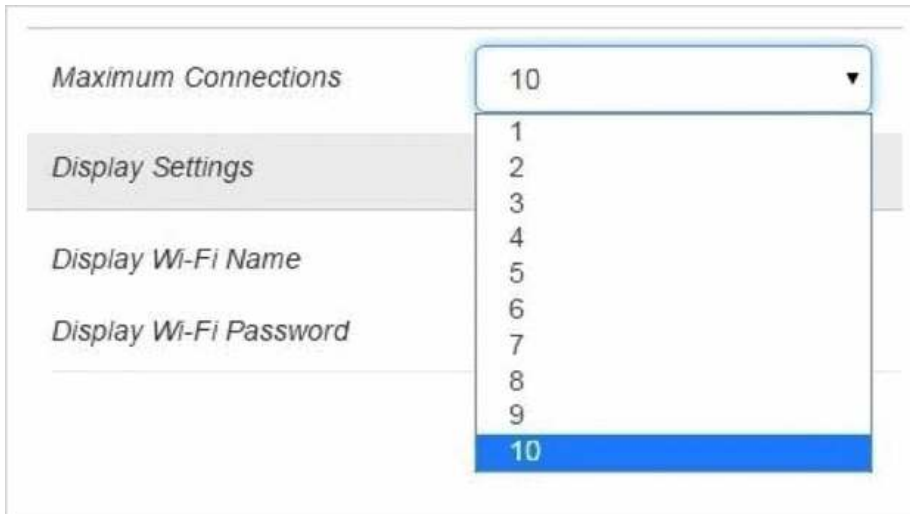

- **Display Wi-Fi Name:** If ON is selected, the Wi-Fi Name will be displayed on your R850 device display menu.
- **Display Wi-Fi Password:** If ON is selected, the Wi-Fi password will be displayed on your R850 device display menu.
- **Wi-Fi Settings Reset:** Click the **Reset** button to reset all Wi-Fi settings to the default.

Wi-Fi Advanced Settings

Configure your device's advanced Wi-Fi settings.

! Caution for Using Wi-Fi Advanced Settings

These advanced settings should only be changed for specific circumstances. Changes to the advanced settings could result in loss of Wi-Fi connection with your devices. Consult your devices' manuals for Wi-Fi specifications.

1. From the Web UI, click **Settings > Wi-Fi > Advanced** to view the wireless network advanced parameters and the WPS settings shown in the following figure.

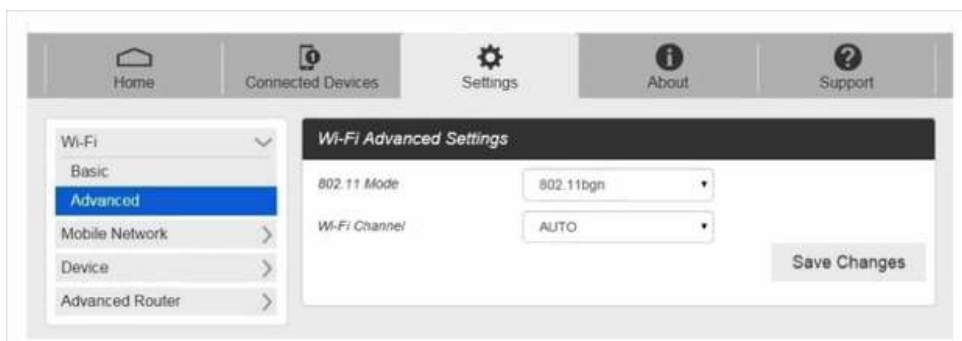

- **802.11 Mode:** Select an 802.11 mode from the drop-down list.



- **Wi-Fi Channel:** Select a Wi-Fi channel from the drop-down list.

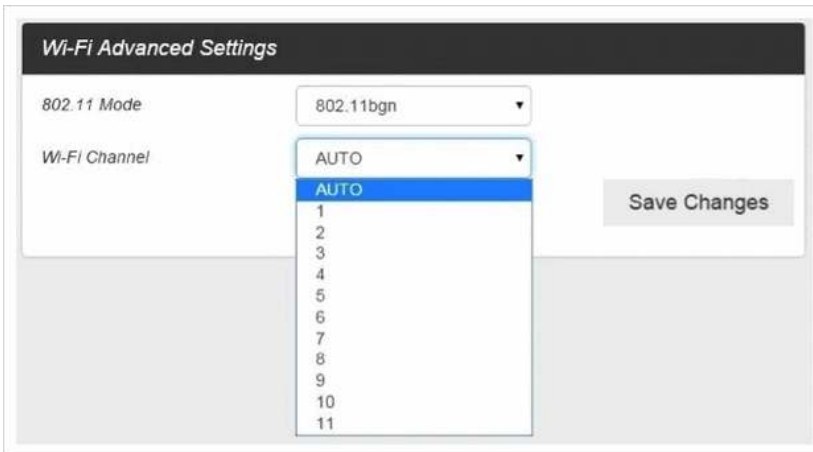

2. Click **Save Changes** to save your settings.

Mobile Network Settings

Manage your mobile network settings.

Caution for Using Mobile Network Settings

Mobile Network Settings should only be used as directed by Sprint Customer Service personnel.

Mobile Settings

1. From the Web UI, click **Settings > Mobile Network > Mobile Settings**. The Mobile Settings page is shown in the following figure.

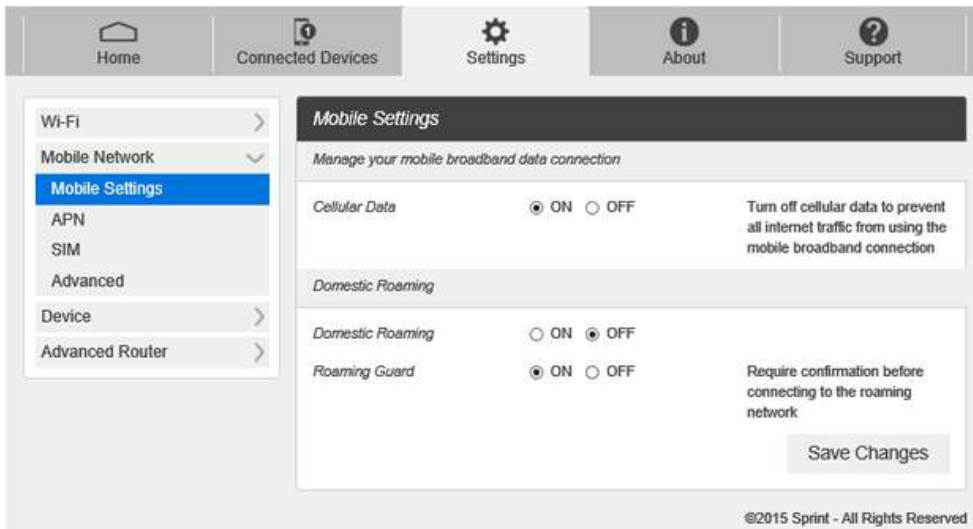

- **Cellular data:** Turn Cellular data on or off. Turn it OFF to prevent all Internet traffic from using the mobile broadband connection.
- **Domestic Roaming:** Turn Domestic Roaming on or off. Turn it OFF to prevent your device from roaming to other service providers' networks.

CAUTION! Allowing roaming could result in additional service charges.

- **Roaming Guard:** Turn Roaming Guard on or off. Turn it ON to require confirmation before connecting to the roaming network.

2. Click **Save Changes** to save your settings.

APN

- From the Web UI, click **Settings > Mobile Network > APN**. The default APN parameters are shown in the following figure. You can use the default APN to connect to the Internet. You can also add new APNs.

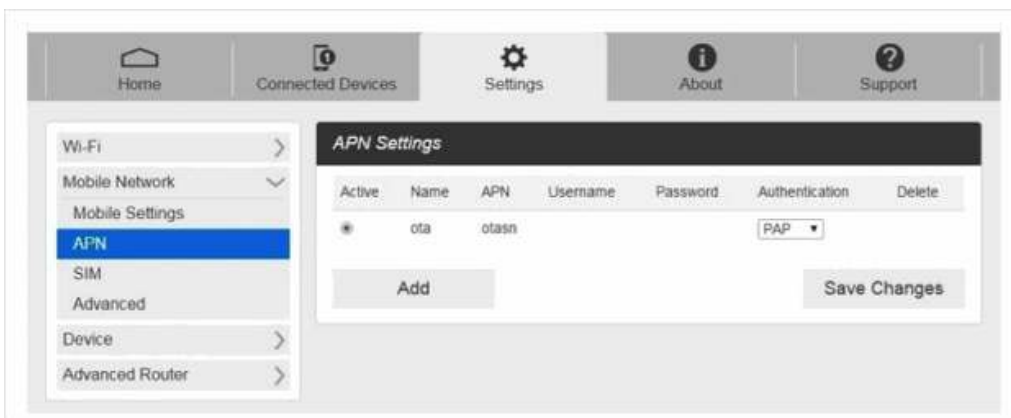

To add a new APN, follow the steps below:

1. Click **Add** to access the following page.

2. Enter the related parameters as described in the following table.

Parameters	Description
Name	Type the profile name.
APN	Type the APN string.
User name	User name is used to obtain authentication from the ISP when the connection is established.
Password	Password is used to obtain authentication from the ISP when the connection is established.
Authentication	Password Authentication Protocol (PAP) provides a simple method without encryption for the peer to establish its identity using a 2-way handshake. Challenge-Handshake Authentication Protocol (CHAP) is used to periodically verify the identity of the peer using a 3-way handshake.

3. Click **Save Changes** to add the new APN.

Additional APN Options

- To activate the new APN, check the circle in front of it and then click **Save Changes**.
- To edit the new APN, click **Edit**, change the settings, and then click **Save**.
- To delete the new APN, click **Delete**.

Note: The default APN cannot be edited or deleted.

SIM

1. From the Web UI, click **Settings > Mobile Network > SIM**. The SIM PIN lock is disabled by default. You can enable it by entering SIM PIN.

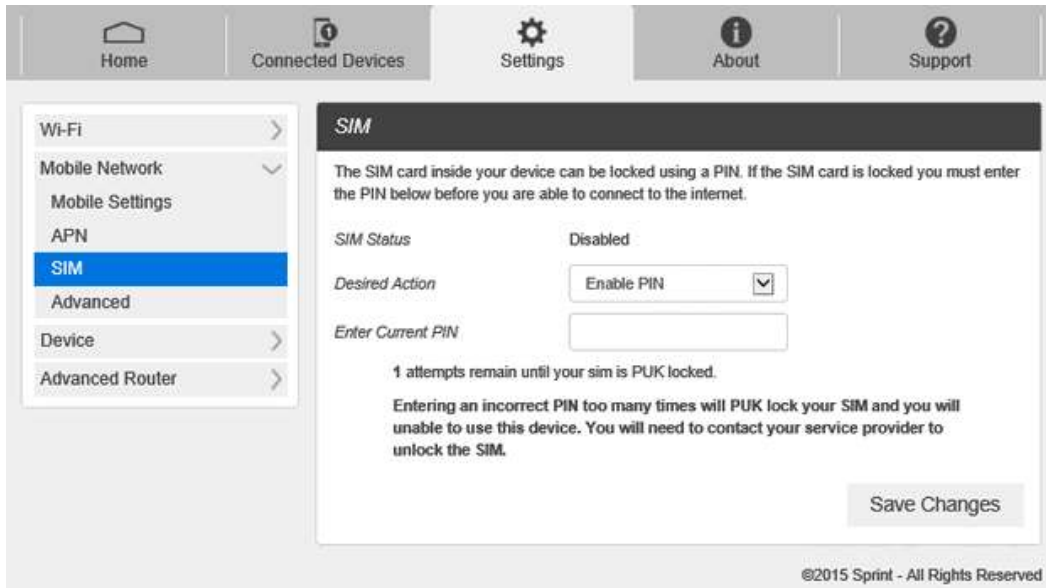

2. Enter the SIM PIN and press **Save Changes**.

- ❖ The SIM Status will be changed to **Enabled**. Once the SIM PIN Lock is enabled, you need to enter SIM PIN to connect to the mobile broadband network each time you power on your R850.

Note: If you enter the wrong SIM PIN three times, your SIM will be disabled permanently until you enter the PUK code from your service provider.

Advanced Mobile Network Settings

⚠ Caution for Using Advanced Mobile Network Settings

Advanced Mobile Network Settings should only be used as directed by Sprint Customer Service personnel. Certain advanced options will reset your device's connections and programming and will require reactivation.

- From the Web UI, click **Settings > Mobile Network > Advanced** to set the mobile network advanced settings on this interface.

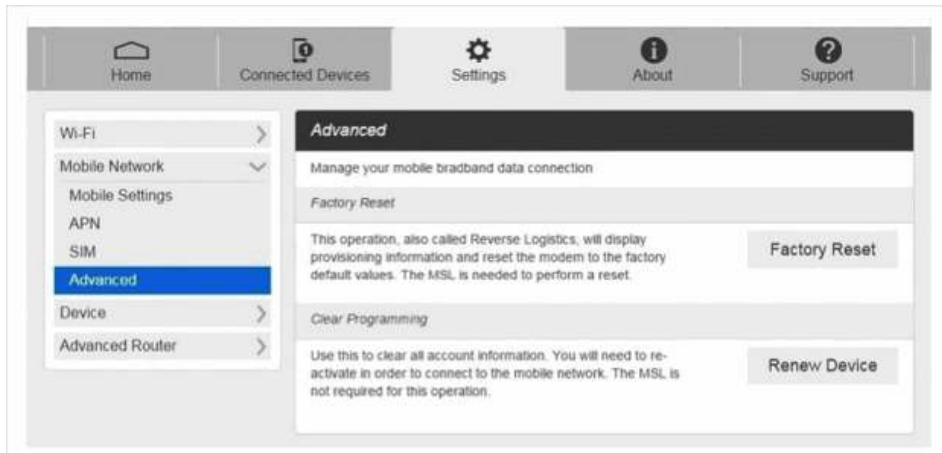

- **Factory Reset:** Click **Factory Reset** to reset the modem to the factory default value.
- **Clear Programming:** Click **Renew Device** to clear all account information.

Device Settings

The Device settings menu lets you set display brightness, manage account password, update software, back up, restore and check system log.

Preferences

1. From the Web UI, click **Settings > Device > Preferences**.

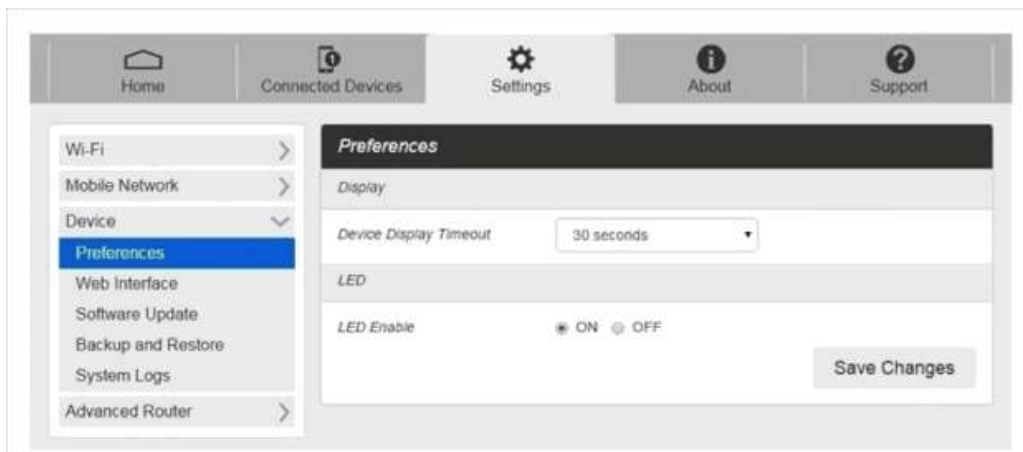

- **Display Timeout:** Select a timeout time from the drop-down list. Your R850 display turns off after this timeout period if there is no menu button action.
 - **LED Enable:** If ON is selected, the LED indicator next to Your R850 display will blink when the device is on. This LED is a power indicator that shows the device is on when the device display is off.
2. Click **Save Changes** to save your settings.

Web Interface

1. From the Web UI, click **Settings > Device > Web Interface**.

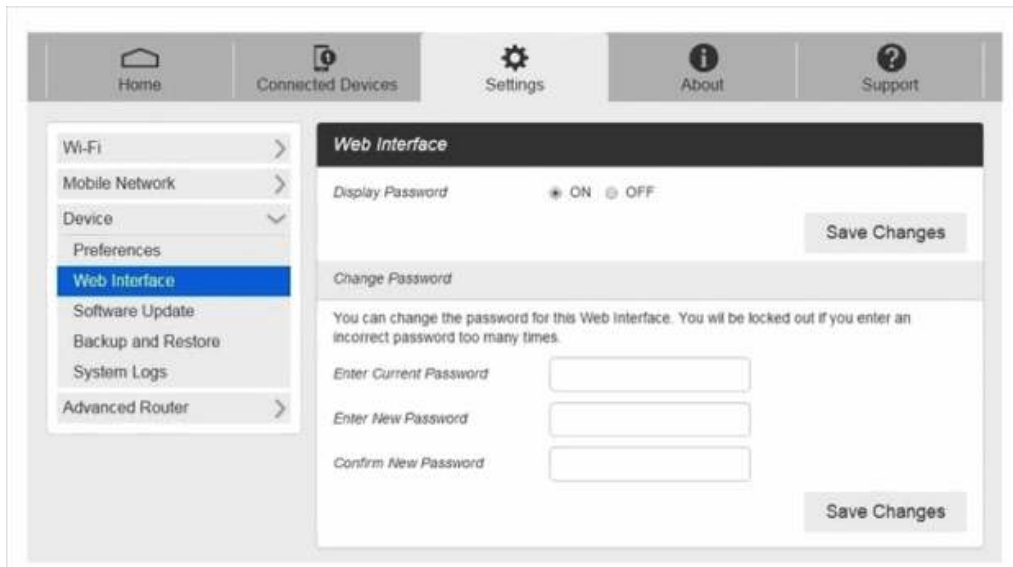

- **Display Password:** If ON is selected, the Web Interface admin password is displayed on your R850 device display menu.
- **Change Password**
 - **Current Password:** Enter the current password.
 - **New Password:** Enter the new password.
 - **Confirm New Password:** Enter the new password again.

2. Click **Save Changes** to save your settings.

Software Update

1. From the Web UI, click **Settings > Device > Software Update**. You can update the software on this page.

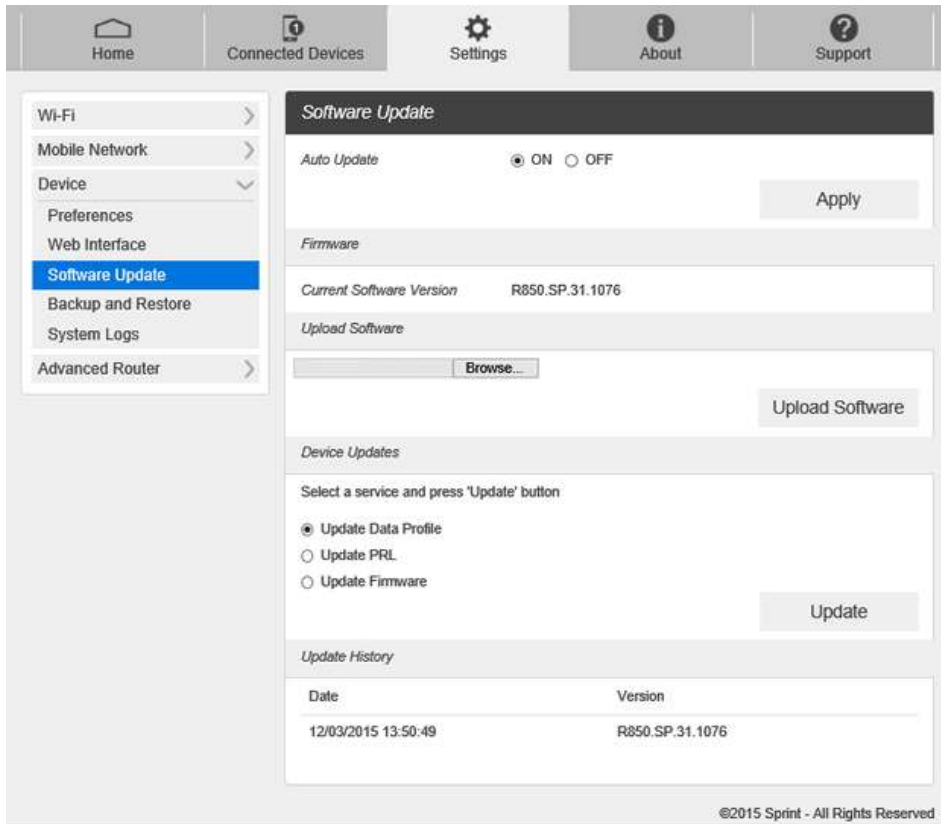

2. Read the onscreen options and click the update you would like to initiate.
 - **Auto Update:** If ON is selected, your R850 will check the latest software periodically and update if new software is available.
 - **Update Software:** If you have a new software file provided by your service provider, you can select the file and update your R850 manually by pressing Update Software button.
 - **Device Updates:** If you would like to check for new data profile, PRL, or Firmware, select the menu and press Update button. Your R850 will check for the latest version, and then if available, will update.
 - **Update History:** Displays the update history list.

Backup and Restore

- From the Web UI, click **Settings > Device > Backup and Restore** to access menus to back up your device settings to your computer, restore from the backup and restore your device to its factory default settings.

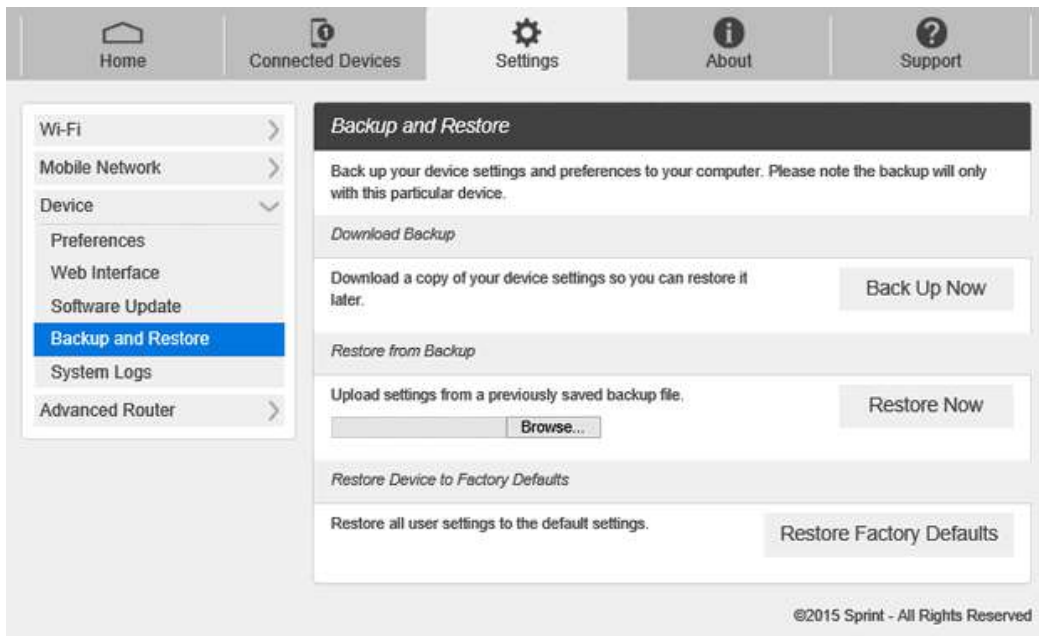

To back up your device settings to your computer, follow the steps below:

1. Click **Back Up Now**.
2. Click **Save** on the pop-up window.
3. Choose a location on your computer to save the backup file.
4. Click **Save**.

To restore from the backup, follow the steps below:

1. Click **Choose File** to select the backup file in your computer.
2. Click **Restore now**.

To restore your device to its factory default settings, follow the steps below:

1. Click **Restore Factory Defaults**.
2. Click **OK** to confirm the command.

System Logs

- From the Web UI, click **Settings > Device > System Logs**, and then click **Download Logs** to download the system logs on this page.

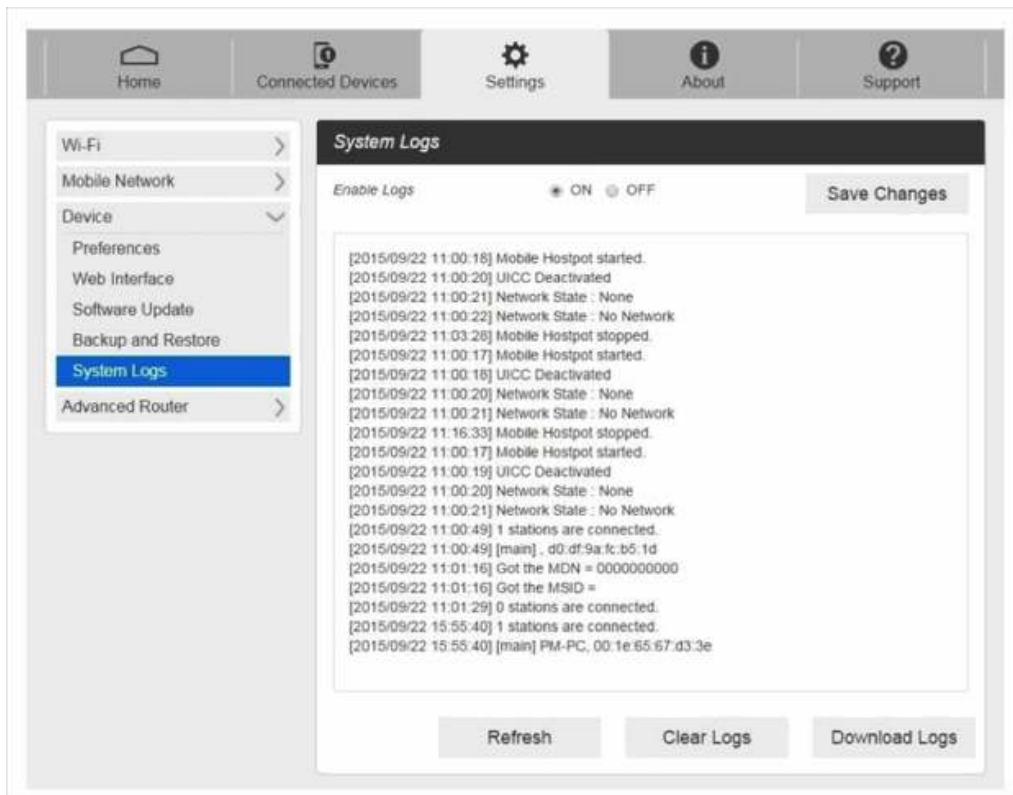

Note: System logs are used for engineering purposes by your service provider. Keep it OFF during regular usage of your device.

Advanced Router Settings

Configure LAN, Firewall, and Customization settings.

LAN Settings

1. From the Web UI, click **Settings > Advanced Router > LAN Settings** to display the router information shown in the following figure.

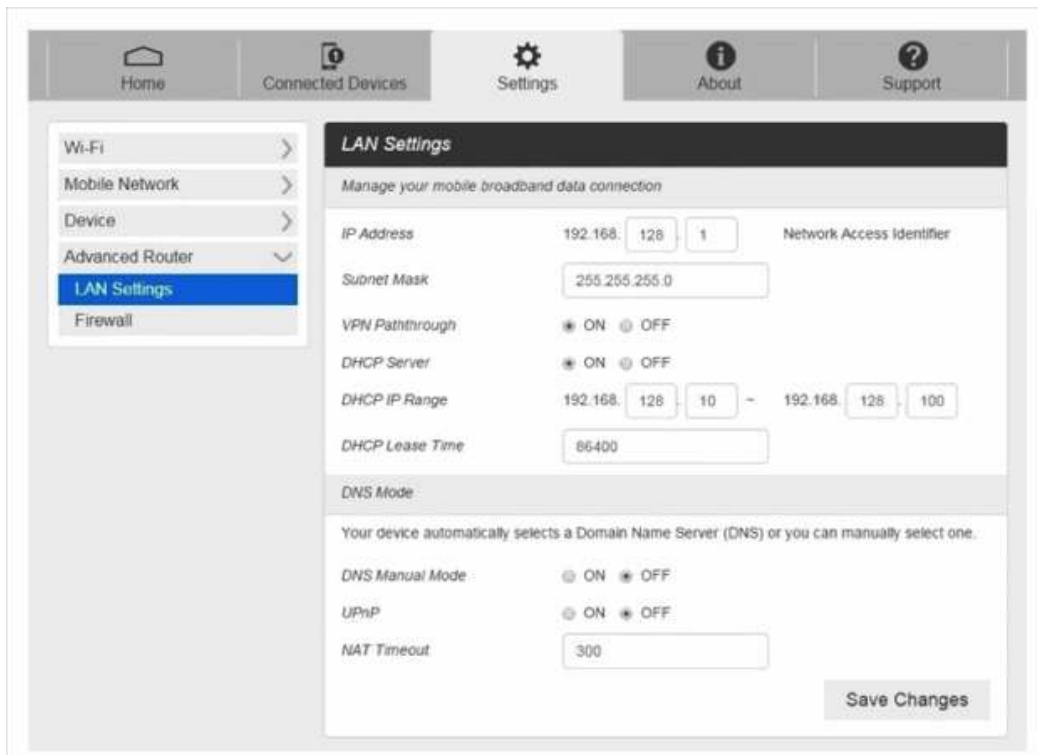

- **IP Address:** IP address for Web User Interface.
- **Subnet Mask:** Subnet mask for the IP address.
- **VPN Pass-through:** VPN pass-through must be enabled if you want to allow VPN tunnels to pass through your device's firewall.
- **DHCP Server:** Enable or disable DHCP Server function.
- **DHCP IP Range:** Allocate begin and end IP address for IP Range.
- **DHCP Lease Time:** Define how long the leased IP address will be. The new IP address will be relocated after the IP address is expired.
- **DNS Manual Mode:** Turn DNS manual mode on or off.
- **UPnP:** Turn UPnP (Universal Plug n Play) mode on or off.
- **NAT Timeout:** Set TCP NAT time.

2. Click **Save Changes** to save your settings.

Firewall

- From the Web UI, click **Settings > Advanced Router > Firewall**. You may set up firewall rules to protect your network from virus and malicious activity on the Internet.

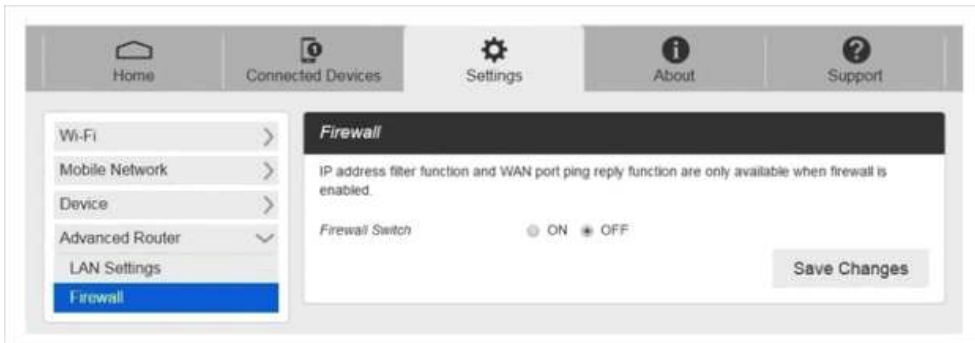

IP Address Filtering

To set IP Address Filtering rules, follow the steps below:

1. Turn on the **Firewall Switch**.
2. Turn on the **IP Address Filtering**.

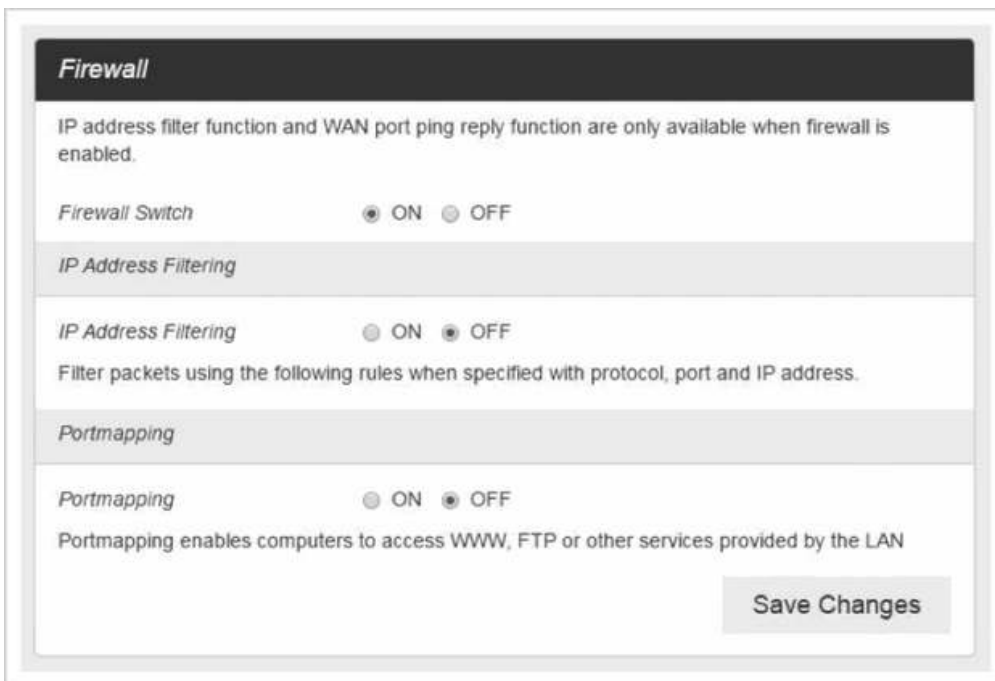

3. Click **Add**.

IP Address Filtering

IP Address Filtering ON OFF

Filter packets using the following rules when specified with protocol, port and IP address.

- LAN/WAN port: The Value range is 1 ~ 65535.
- Settings not enabled until applied.

LAN IP Address	LAN Port	WAN IP Address	WAN Port	Protocol	Status	Options
<input type="text"/>	<input type="text"/>	<input type="text"/>	<input type="text"/>	TCP ▼	ON ▼	OK Cancel

Add

4. Enter the related parameters as described in the following table.

Parameters	Description
LAN IP Address	Enter the LAN IP address.
LAN Port	Set the LAN port.
WAN IP Address	Enter the WAN IP address.
WAN Port	Set the WAN port.
Protocol	Set which protocol will be used for filtering.
Status	Set how to handle the packet if it matches with the rule.

5. Click **Save Changes** to add the new filtering rule.

Port Mapping

To set port mapping rules, follow the steps below:

1. Turn on the **Firewall Switch**.

2. Turn on **Port mapping**.

Portmapping

Portmapping ON OFF

Portmapping enables computers to access WWW, FTP or other services provided by the LAN

- IP Address: Specify LAN address. Packets which match the specified conditions will be forwarded to this address.
- LAN/WAN port: Port of the computer providing services. It is a single port with value range of 1 ~ 165535.
- Protocol: Protocols applied by services.
- Settings not enabled until applied.

Name	WAN Port	LAN IP Address	LAN Port	Protocol	Status	Options
No Item						

Add

Save Changes

3. Click **Add**.

Portmapping

Portmapping ON OFF

Portmapping enables computers to access WWW, FTP or other services provided by the LAN

- IP Address: Specify LAN address. Packets which match the specified conditions will be forwarded to this address.
- LAN/WAN port: Port of the computer providing services. It is a single port with value range of 1 ~ 165535.
- Protocol: Protocols applied by services.
- Settings not enabled until applied.

Name	WAN Port	LAN IP Address	LAN Port	Protocol	Status	Options
<input type="text"/>	<input type="text"/>	<input type="text"/>	<input type="text"/>	TCP ▼	ON ▼	OK Cancel

Add

Save Changes

4. Enter the related parameters as described in the following table.

Parameters	Description
Name	Enter a name for the rule.
WAN Port	Set the WAN port.
LAN IP Address	Enter the LAN IP address.
LAN Port	Set the LAN port.
Protocol	Set which protocol will be used for filtering.
Status	Set how to handle the packet if it matches with the rule.

5. Click **Save Changes** to add the new port mapping rule.

About

View your device's connection information, firmware information, WWAN information, Wi-Fi details and device information.

- From the Web UI main screen, click the **About** tab to view the available information.



Support Tab

Obtain support information from the Web UI Support Tab.

- From the Web UI main screen, click the **Support** tab to view the available options.

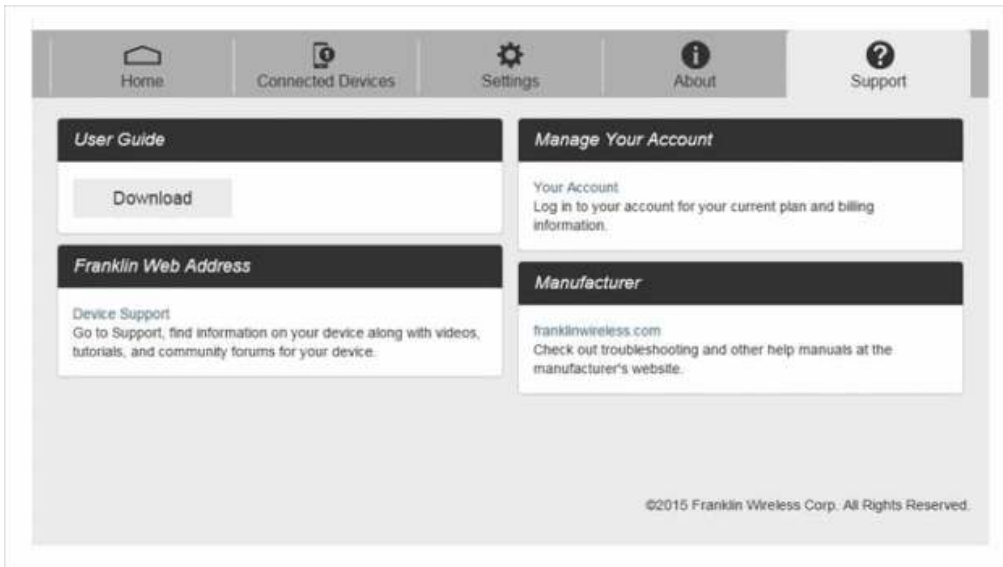

Appendix

The following topics cover items such as troubleshooting, device specifications, applicable warranty and service information, customer service contacts, and applicable trademark and copyright notices.

Troubleshooting

Check below for troubleshooting solutions for common device issues.

Check Here First

Issue: Unable to connect via Wi-Fi (WLAN)

Solution 1: Check whether the mobile broadband device is properly connected to the computer or other external device. If not, make sure you have the right Wi-Fi name selected and the Wi-Fi password is entered correctly.

Solution 2: If SHARED WEP is the security method being used, check whether the correct WEP key is entered. If the WEP key is unknown, see [Wi-Fi Basic Settings](#) to reset the WEP key and reconnect the device.

Solution 3: Check whether the correct WPA key is set. If the WPA key is unknown, see [Wi-Fi Basic Settings](#) to reset the mobile broadband device or see the WLAN Initialization Sticker to reset the WPA key, and then reconnect the device. WPA/WPA2 security may not be supported depending on the Wi-Fi device. See the Wi-Fi device user guide for more information.

Issue: Internet connection fails.

Solution 1: Make sure that you are within the service area.

Solution 2: If signal reception is poor, move to where signal reception is good and then reconnect.

Solution 3: The access point might be busy depending on the time of day. Wait a little and then reconnect.

Solution 4: Activate the Web UI and make sure that network settings are correct.

Issue: Transmission fails quickly.

Solution 1: Make sure that the mobile broadband device is properly connected to the PC or other device via Wi-Fi.

Solution 2: Signal reception might be poor. Check transmission where signal reception is good.

Solution 3: Restart the mobile broadband device.

Solution 4: Check the mobile broadband device battery level. If battery level is low, charge with AC charger. See [Charge the Battery](#) for how to charge.

Issue: Transmissions are slow.

Solution 1: Signal reception might be poor. Check transmission where signal reception is good.

Solution 2: Connection might be poor. Try again after a while.

Issue: Forgot PIN / Unknown PIN Unblocking Key (PUK) / SIM card is locked.

Solution: Contact Customer Service.

Issue: SIM card is not recognized.

Solution 1: Check whether the SIM card is properly installed. For details, see [Insert or Remove a SIM Card](#).

Solution 2: Check the SIM card for damage.

Solution 3: Check the SIM card IC chip for scratches/corrosion.

Solution 4: Dirty SIM card (particularly IC chip) may prevent recognition. Clean gently with a soft cloth.

Solution 5: Contact Customer Service.

Issue: How do I return the mobile broadband device to the default settings (reset)?

Solution 1: Use the Web UI to reset the device. For details, see [Web UI Window](#).

Issue: An old phone number appears on the Web UI.

Solution: The Web UI may display an old phone number depending on subscription terms or cancellation method.

Issue: The mobile broadband device operation is unstable.

Solution 1: Avoid extremely high/low temperatures, high humidity, direct sunlight, dusty areas, etc. Read "Safety Precautions" for use in a proper environment.

Solution 2: Avoid invalid software. Operation is unguaranteed for Internet connection, etc., using other-party software.

Issue: The connection suddenly failed.

Solution 1: The connection method may have been changed. Check connection mode on the mobile broadband device display.

Solution 2: Restart the mobile broadband device.

Specifications

The following tables list the specifications for the mobile broadband device, charger and the device materials.

Mobile Broadband Device Specifications

Item	Description
Model name	R850 Mobile Hotspot
Dimensions¹	12.5mm (H) x 90.1mm (W) x 67mm (D)
Weight	97g
Interface	Web UI
Power consumption	Normal state: 1.26 Watts Max state : 2.52 Watts
Operating system	Linux OS
Frequency	LTE B2 DL: 1930 ~ 1990 MHz UL: 1850 ~ 1910 MHz LTE B4 DL: 2110 ~ 2155 MHz UL: 1710 ~ 1755 MHz LTE B5 DL: 869 ~ 894 MHz UL: 824 ~ 849 MHz LTE B12 DL: 729 ~ 746 MHz UL: 699 ~ 716 MHz LTE B25 DL: 1930 ~ 1995 MHz UL: 1850 ~ 1915 MHz LTE B26 DL: 859 ~ 894 MHz UL: 814 ~ 849 MHz LTE B41 DL: 2496 ~ 2690 MHz UL: 2496 ~ 2690 MHz WIFI(B/G/N) 2412MHz ~ 2462MHz
Compatible networks	LTE category 4 / Wi-Fi IEEE802.11 b/g/n
Charging time²	3 hours 40 minutes
Continuous standby time³	41 hours
Continuous communication time³	8 hours

Item	Description
Communication speed	LTE category 4 DL : 150Mbps UP : 50Mbps

¹ Approximate values

² Varies by ambient temperature, battery usage, etc.

³ Varies by environment, signal conditions, etc.

AC Charger Specifications

Item	Description
Rated input voltage	100-240Vac
Operating range	90-264Vac
Rated input frequency	50/60Hz +/- 3Hz
Nominal dc output voltage	+5.0V (±5%)
Rating load current	1.0A

Materials Specifications

Parts	Materials/Finishing
A cover	PC(Black), SF coating
B cover	PC(Black)
Battery cover	PC(Black), SF coating
A deco	PC(Black), UV(Gloss 80%)
Power key	PC(Milky White), Spray(Black), UV(Gloss 80%)
LCD Bracket	PC(Black)
Rubber feet	Silicon(Black)

Warranty and Service

The following topics outline your device's warranty and service information.

Warranty

Your device purchase includes Warranty.

- Confirm shop name and purchase date.
- Read contents of Warranty and keep it in a safe place.

- Check warranty period in the Warranty.

Services

Before submitting your device for repairs, contact Customer Service or General Information; be prepared to describe problem in detail.

- During the warranty period, repairs will be made under the terms and conditions described in the Warranty.
- After the warranty period, repairs will be upon request; if said repairs can be made, you will be charged for them.

Customer Service

For mobile broadband device or service information, call general information. For repairs, call customer assistance.

Sprint Customer Service

You can reach Sprint Customer Service online or by calling toll-free.

- Sign in to your account at sprint.com/mysprint.
- Call toll-free at 1-888-788-4727 (business use) or 1-888-211-4727 (personal use).

Trademarks and Copyright Information

The names of companies, products, and services used in this guide are registered trademarks or trademarks of the respective companies.

Franklin Wireless logo is a trademark or registered trademark of Franklin Wireless Corporation in US. Copyright © 2016 Franklin Wireless Corporation. All rights reserved.

Safety and Notices

The following topics address important safety precautions, general notes, and required RF exposure information for your mobile broadband device.

Safety Precautions

The following topics outline important safety precautions that must be observed when using your device.

Important Notice

Due to the nature of wireless communications, transmission and reception of data can never be guaranteed. Data may be delayed, corrupted (i.e., have errors) or be totally lost. Although significant delays or losses of data are rare when wireless devices such as the Sprint R850 Mobile Hotspot are used in a normal manner with a well-constructed network, your device should not be used in situations where failure to transmit or receive data could result in damage of any kind to the user or any other party, including but not limited to personal injury, death, or loss of property. Sprint accepts no responsibility for damages of any kind resulting from delays or errors in data transmitted or received using your device, or for failure of your device to transmit or receive such data.

Safety and Hazards

Do not operate your device under the following conditions.

- In areas where blasting is in progress
- Where explosive atmospheres may be present
- Near medical equipment
- Near life support equipment, or any equipment that may be susceptible to any form of radio interference

In such areas, your device **MUST BE POWERED OFF**. Your device can transmit signals that could interfere with this equipment.

Do not operate your device in any aircraft, whether the aircraft is on the ground or in flight. In aircraft, your device **MUST BE POWERED OFF**. When operating, your device can transmit signals that could interfere with various onboard systems.

Note: Some airlines may permit the use of cellular phones while the aircraft is on the ground and the door is open. Your device may be used at this time.

The driver or operator of any vehicle should not operate the device while in control of a vehicle. Doing so will detract from the driver or operator's control and operation of that vehicle. In some jurisdictions, operating such communications devices while in control of a vehicle is an offense.

Proper Battery Use and Disposal

Follow these guidelines to ensure safe and responsible battery use.

- Do not open, disassemble, puncture, crush, bend, or shred.
- Do not expose to water or other liquids, fire, explosion, or other hazards.
- Use the battery only in the Sprint R850 Mobile Hotspot.
- If using with a charger, use only the AC charger supplied with your device.
- Do not short circuit the battery.
- When replacing a battery, use the same model of battery that was supplied with your device.
- Follow local regulations when disposing of a used battery.
- Avoid dropping your device or the battery. If dropped and you suspect damage, take it to a service center for inspection.

CAUTION! Improper battery use may result in a fire, explosion, or other hazard.

FCC Compliance

This device complies with part 15 of the FCC Rules. Operation is subject to the following two conditions: (1) This device may not cause harmful interference, and (2) this device must accept any interference received, including interference that may cause undesired operation.

Note: Any changes or modifications not expressly approved by the party responsible for compliance could void the user's authority to operate this equipment.

This equipment has been tested and found to comply with the limits for a Class B digital device, pursuant to part 15 of the FCC Rules. These limits are designed to provide reasonable protection against harmful interference in a residential installation. This equipment generates, uses and can radiate radio frequency energy and, if not installed and used in accordance with the instructions, may cause harmful interference to radio communications. However, there is no guarantee that interference will not occur in a particular installation. If this equipment does cause harmful interference to radio or television reception, which can be determined by turning the equipment off and on, the user is encouraged to try to correct the interference by one or more of the following measures:

- Reorient or relocate the receiving antenna.
- Increase the separation between the equipment and receiver.
- Connect the equipment into an outlet on a circuit different from that to which the receiver is connected.
- Consult the dealer or an experienced radio/TV technician for help.

RF Exposure Information and Specific Absorption Rate (SAR) Information

The following topics detail the specific absorption rate (SAR) information, electromagnetic safety information, and radiofrequency (RF) exposure information for this device.

This device is designed and manufactured not to exceed the emission limits for exposure to radio frequency (RF) energy set by the Federal Communications Commission of the United States.

During SAR testing, this device is set to transmit at its highest certified power level in all tested frequency bands, and placed in positions that simulate RF exposure in usage against, and near the body with the separation of 10 mm. Although the SAR is determined at the highest certified power level, the actual SAR level of the while operating can be well below the maximum value. This is because the device is designed to operate at multiple power levels so as to use only the power required to reach the network. In general, the closer you are to a wireless base station antenna, the lower the power output. Safety and Notices 90

The exposure standard for wireless employs a unit of measurement known as the Specific Absorption Rate, or SAR. The SAR limit set by the FCC is 1.6W/kg.

Tests for SAR are conducted using standard operating positions accepted by the FCC with the device transmitting at its highest certified power level in all tested frequency bands.

The FCC has granted an Equipment Authorization for this model device with all reported SAR levels evaluated as in compliance with the FCC RF exposure guidelines. SAR information on this model device is on file with the FCC and can be found under the Display Grant section of <https://www.fcc.gov/general/fcc-id-search-page> after searching on **FCC ID: XHG-R850**

More information on the device's SAR can be found from the following FCC website: <https://www.fcc.gov/general/fcc-id-search-page>.

While there may be differences between the SAR levels of various devices and at various positions, they all meet the government requirement.

SAR compliance for body operation is based on a separation distance of 10 mm between the unit and the human body. Carry this device, at least 10 mm away from your body to ensure RF exposure level compliant or lower to the reported level. To support body operation, choose the belt clips or holsters, which do not contain metallic components, to maintain a separation of 10 mm between this and your body.

Index

A	I
About 50	Important Notice 58
Additional Information 2	Introduction 1
Admin Log In 30	iPad
Advanced Router Settings 45	Connect Wi-Fi 22
Android Device	M
Connect Wi-Fi 25	Mac
Appendix 53	Connect Wi-Fi 16
B	Mobile Network Settings 37
Battery	N
Charge 11	Network Name 2
Insert 9	O
Battery Use 9	OS 1
Before Your Begin 1	P
C	Package Contents 2
Compatible Operating Systems 1	Parts and Functions 3
Connect an iPhone or an iPod Touch 19	Power Key 4
Connect iPhone/iPod Touch/iPad 19	Power Off 13
Connect with Wi-Fi (WLAN) 14	Power On 12
Connected Devices 30	Proper Battery Use and Disposal 59
Customer Service 57	R
D	RF Exposure Information and SAR
Data Transfer Volume and Transfer Speed 5	Information 60
Device	S
Turn On and Off 12	Safety and Hazards 58
Device Layout (illustration) 3	Safety and Notices 58
Device Settings 41	Safety Precautions 58
F	Security Key 2
FCC Compliance 59	Services 57
G	Settings 29
Get Started 3	Settings Tab 32
H	SIM Card 5
Home 29	Handling 5
Home Screen 4	Insert or Remove 6
Home Screen Icons 4	Specifications 54
Home Screen Layout 4	AC charger 56

- Materials 56
- Mobile broadband device 55
- SSID 2
- Support Tab 51

T

- Troubleshooting 53
- Turn Device Off 13
- Turn Device On 12

W

- Warranty 56
- Warranty and Service 56
- Web UI
 - Overview 29
 - Window 29
- Wi-Fi 2, 14
 - Activate 14
 - Advanced Settings 36
 - Basic Settings 32
 - Connect Mac 16
 - Connect Windows PC 15
 - Overview 14
- Windows PC
 - Connect Wi-F 15
- WLAN
 - Activate 14
 - Overview 14